

SOLUTIONS FOR



Vehicle
Garages



Professional
Tyre Shops



Garage Equipment
Manufacturers



2019-2020

Complete
TYRE CARE,
MADE EASY

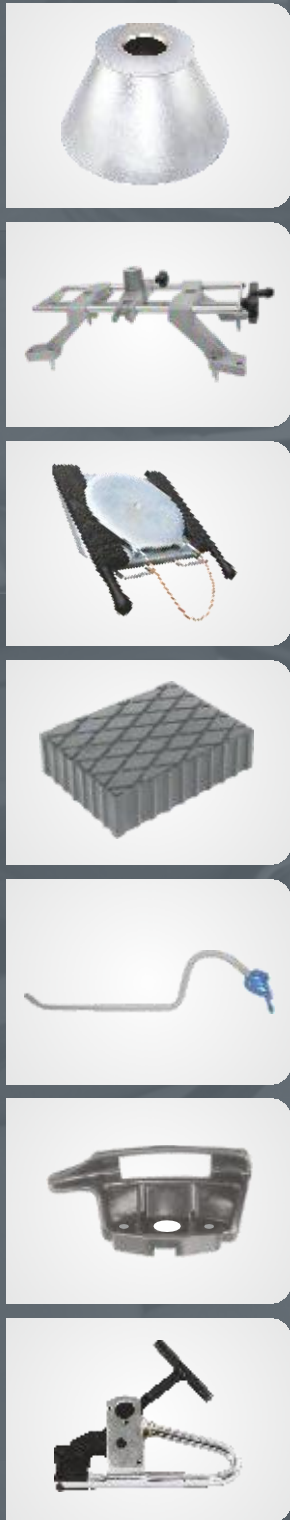
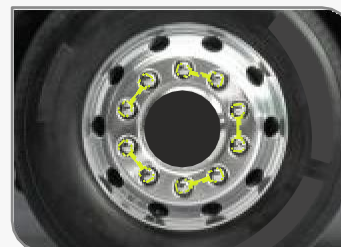



31 110040UA



32 1100518 112018



33 1100528 1106028



34 1105038 1120038



35 1105048 1150048



36 1100058



36 1100050



36 1110060

31 Universal Wheel Balancing Adaptor

Weight:
5.00kg

Code No.
110040UA

Material : Special Steel.

Finish : Nickel Plating.

Use : Standard centering device to balance rims without central hole.
Suitable for 36 / 38 / 40 mm shaft dia.
Valid for rims with 3, 4, 5 & 6 screws.



32 Balancing Weights for Steel Rims

Weight:	Code No.	Weight:	Code No.
5gms	1100518	65gms	1106518
10gms	1101018	70gms	1107018
15gms	1101518	75gms	1107518
20gms	1102018	80gms	1108018
25gms	1102518	85gms	1108518
30gms	1103018	90gms	1109018
35gms	1103518	95gms	1109518
40gms	1104018	100gms	1110018
45gms	1104518	105gms	1110518
50gms	1105018	110gms	1111018
55gms	1105518	115gms	1111518
60gms	1106018	120gms	1112018

Use : To accurately balance the wheels for proper run on the roads.

33 Wheel Balancing Clip Weights for Alloy Rims

Weight:	Code No.	Weight:	Code No.
5gms	1100528	35gms	1103528
10gms	1101028	40gms	1104028
15gms	1101528	45gms	1104528
20gms	1102028	50gms	1105028
25gms	1102528	55gms	1105528
30gms	1103028	60gms	1106028

34 Wheel Balancing Weights for LCV Steel Rims

Weight:	Code No.	Weight:	Code No.
50gms	1105038	125gms	1112538
75gms	1107538	150gms	1115038
100gms	1110038	200gms	1120038

35 Wheel Balancing Weights for Truck/Bus Steel Rims

Weight:	Code No.	Weight:	Code No.
50gms	1105048	250gms	1125048
75gms	1107548	300gms	1130048
100gms	1110048	400gms	1140048
150gms	1115048	500gms	1150048
200gms	1120048		

36 Wheel Balancing Sticker Weights for Alloy Rims

Material:	Weight:	Code No.
Lead	Per Strip 60gms	1100058
Steel	Per Strip 50gms	1100050
Steel	Per Strip 60gms	1110060

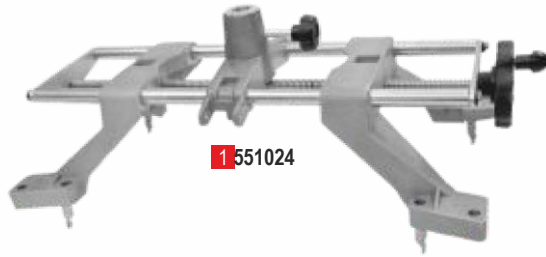

1 551024

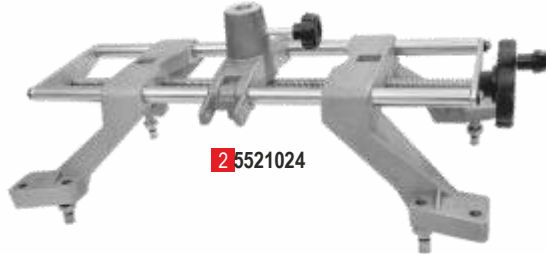

2 5521024

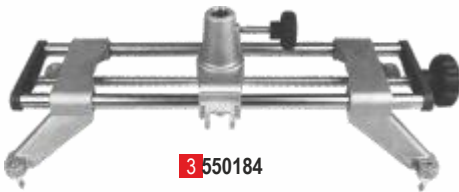

3 550184



4 550244

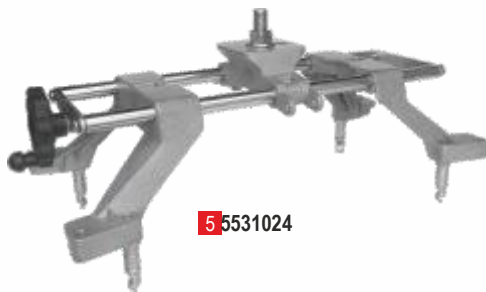

5 5531024



6 5541024



7 550127

7 550147

7 550197

7 550227

7 550257

7 550218

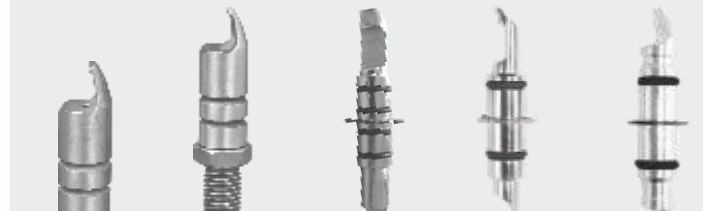

7 550228

7 550328

7 550428

7 550628

7 550728

1 Clamp for Measuring Head of Wheel Alignment M/c Four Point with PUSH TYPE Fingers (Claws) - Passenger Car/Truck / Buses

Rim Size:	Bore Size:	Weight:	Code No.
12" to 25"	15mm, 16mm, 20mm	3.500kg	551024

Use : For holding sensors of Wheel Alignment Machine.

Packing : Two pieces packed in thermocol box and cardboard box to prevent damage in transit.

2 Clamp for Measuring Head of Wheel Alignment M/c Four Point with THREADED Fingers (Claws) - Passenger Car/Truck / Buses

Rim Size:	Bore Size:	Weight:	Code No.
12" to 25"	15mm, 16mm, 20mm	3.500kg	5521024

Use : For holding sensors of Wheel Alignment Machine.

Packing : Two pieces packed in thermocol box and cardboard box to prevent damage in transit.

3 Clamp for Measuring Head of Wheel Alignment M/c Four Point with PUSH TYPE Fingers (Claws) - Passenger Car

Rim Size:	Bore Size:	Weight:	Code No.
9" to 20"	15mm, 16mm	3.000kg	550184

Use : For holding sensors of Wheel Alignment Machine.

Packing : Two pieces packed in thermocol box and cardboard box to prevent damage in transit.

4 Clamp for Measuring Head of Wheel Alignment M/c Four Point with PUSH TYPE Fingers (Claws) - Truck / Buses

Rim Size:	Bore Size:	Weight:	Code No.
9" to 26"	15mm, 16mm	3.500kg	550244

Use : For holding sensors of Wheel Alignment Machine.

Packing : Two pieces packed in thermocol box and cardboard box to prevent damage in transit.

5 Clamp for Measuring Head of Wheel Alignment M/c Four Point with PUSH TYPE Fingers (Claws) - Passenger Car / Truck / Buses

Rim Size:	Weight:	Code No.
12" to 24"	4.500kg	5531024

Use : For holding sensors of Wheel Alignment Machine.

Packing : Two pieces packed in thermocol box and cardboard box to prevent damage in transit.

6 Wheel Alignment Clamp (5 PIN)

Bore Size:	Weight:	Code No.
15mm	4.400kg	5541024

Material : Aluminum Casting with red Powder Coating.

Use : Used especially for alignment of Mercedes / BMW / Audi.

7 Wheel Alignment Clamp (5 PIN)

Length:	Dia:	Weight:	Code No.
48mm	12mm	30gms	550127
58mm	12mm	37gms	550147
89mm	12mm	70gms	550197
48mm	14mm	30gms	550227
70mm	12mm	45gms	550257
44mm	10mm	36gms	550218
46.5mm	15mm	35gms	550228
74mm	15mm	70gms	550328
79mm	12mm	42gms	550428
86mm	14mm	62gms	550628
85mm	14mm	71gms	550728

Material : Made from Stainless Steel & Carbon Steel.

Use : Set of 4 fingers (claws) suitable for Steel & Alloy rims.

Finger 550228 fits on 550218 to make Finger 550328.

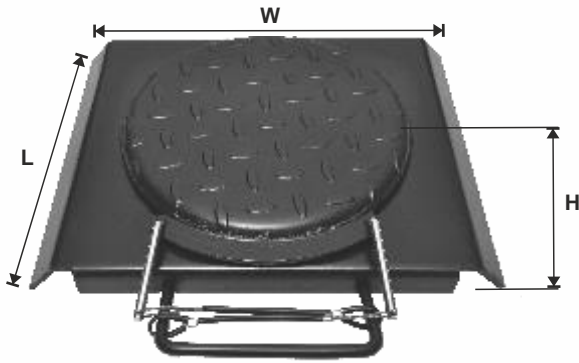

8 1100017

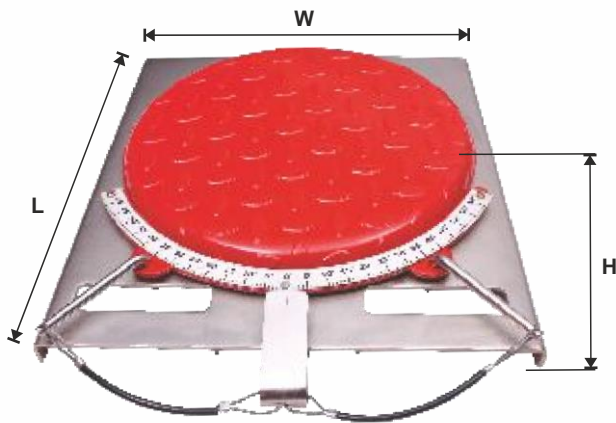

9 1100117

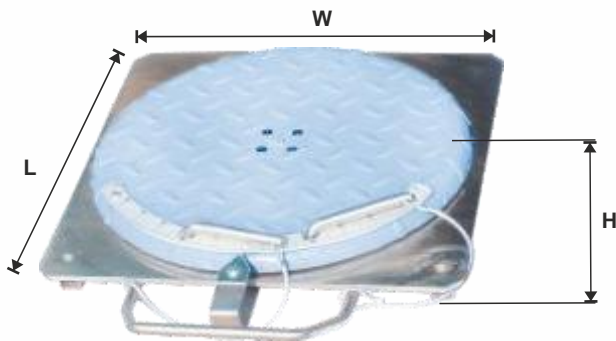

10 1100817

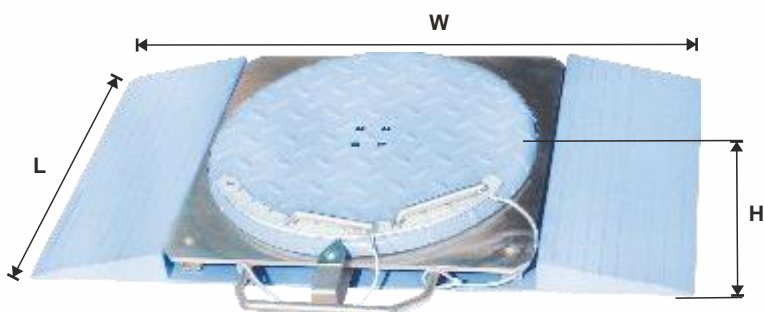

11 1101017

8 Mechanical Turn Table

Dia (Top Plate): 275mm	Weight: 9.00 kg	Code No. 1100017
----------------------------------	---------------------------	----------------------------

Size : L-320mm, W-400mm, H-50mm

Capacity: 1000kg each.

Material : Made from heavy duty Steel Sheet. Black Powder Coated to prevent rusting. Steel Balls (Ø15mm) used in Plastic cage.

Use : Used for easy turning of tyre left / right during alignment of the Passenger Car.

9 Mechanical Turn Table with Scale

Dia (Top Plate): 310mm	Weight: 9.240kg	Code No. 1100117
----------------------------------	---------------------------	----------------------------

Size : L-380mm, W-350mm, H-45mm

Capacity: 1000kg each having scale of +0°-60°

Material : Made from heavy duty Steel Sheet. Steel Balls (Ø15mm) used in Plastic cage.

Use : Used for easy turning of tyre left / right during alignment of the Passenger Car.

10 Mechanical Turn Table with Scale

Dia (Top Plate): 350mm	Weight: 12.440kg	Code No. 1100817
----------------------------------	----------------------------	----------------------------

Size : L-370mm, W-370mm, H-50mm

Capacity: 1500kg each having scale of +0°-60°

Material : Made from heavy duty Steel Sheet. Electroplated to prevent rusting. Steel Balls (Ø12mm) used in Plastic cage.

Use : Used for easy turning of tyre left / right during alignment of the Passenger Car.

11 Mechanical Turn Table for Passenger Car with Scale, Ramp & Centre Line

Dia (Top Plate): 350mm	Weight: 18.860kg	Code No. 1101017
----------------------------------	----------------------------	----------------------------

Size : L-370mm, W-670mm, H-53mm

Capacity: 1500kg each having scale of +0°-60°

Material : Special Steel. Electro Less Plating. Steel Balls (Ø12mm) used in Plastic cage.

Use : Used for easy turning of tyre left / right during alignment of the Passenger Car. Ramp is made on Turn Table 1100817.

12 Mechanical Turn Table with Scale & Rubber Stoppers (Light Weight)

Dia (Top Plate): 350mm	Weight: 6.220kg	Code No. 1101317
----------------------------------	---------------------------	----------------------------

Size : L-395mm, W-395mm, H-50mm

Capacity: 1500kg each having scale of +0°-60°

Material : Made from special grade of Aluminum. Steel Balls (Ø10mm) used in Plastic cage.

Use : Used for easy turning of tyre left / right during alignment of the Passenger Car.

Rubber Stoppers Only (For Turn Table 1101317)

Qty: Set of 2pcs	Weight: 153gms per pc.	Code No. 1101317RS
----------------------------	----------------------------------	------------------------------

Size : L-322mm, W-55mm, H-16mm

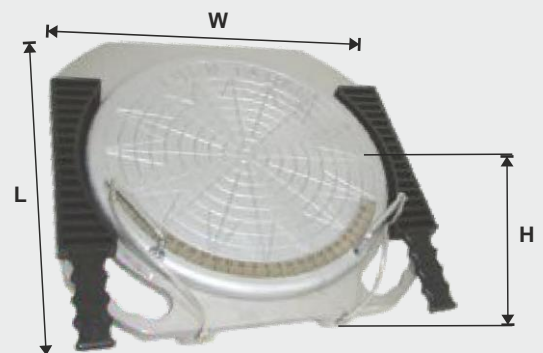

12 1101317

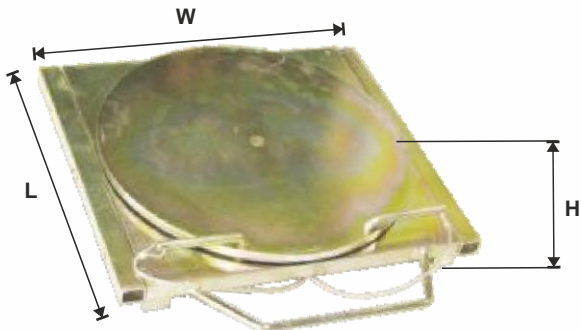

13 1100217

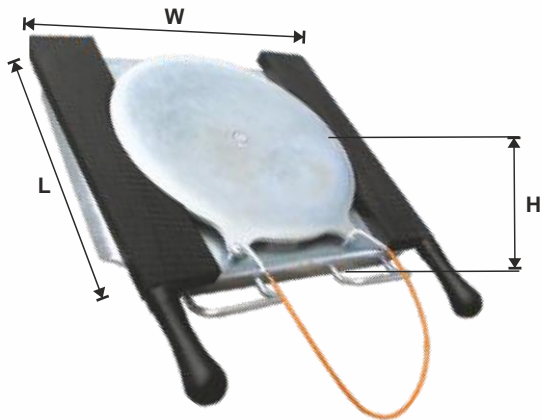

14 1100917



15 1101417

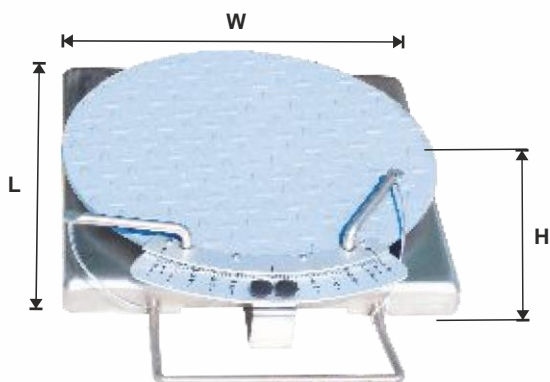

16 1100317

13 Mechanical Turn Table (Heavy Duty)

Dia (Top Plate):	Weight:	Code No.
350mm	27.260kg	1100217

Size : L-350mm, W-400mm, H- 50mm

Capacity: 2500kg each.

Material : Special Steel. Zinc Plating. Steel Balls (Ø12mm) used in Steel cage.

Use : Used for easy turning of tyre left / right during alignment of Light Commercial Vehicles.

14 Mechanical Turn Table with Rubber Stoppers

Dia (Top Plate):	Weight:	Code No.
360mm	15.180kg	1100917

Size : L-400mm, W-470mm, H-50mm

Capacity: 1500kg each.

Material : Special Steel. Zinc Plating. Steel Balls (Ø12mm) used in Plastic cage.

Use : Used with 3D Wheel Alignment Machines for easy turning of tyre left / right.

Rubber Stoppers Only (For Turn Table 1100917)

Qty:	Weight:	Code No.
Set of 2pcs	2.600kg per pc.	1100917RS

Size : L-540mm, W-90mm, H-50mm

15 Mechanical Turn Table for Truck / Buses (Light Weight)

Dia:	Weight:	Code No.
400mm	6.600kg	1101417

Thickness: 18mm

Capacity: 6000kg each.

Material : Made from special grade of Aluminum. Powder Coating Steel Balls. (Ø10mm).

Use : Used for easy turning of tyre left / right during alignment of Light Commercial Vehicles.

16 Mechanical Turn Table for Truck / Buses with Scale

Dia (Top Plate):	Weight:	Code No.
480mm	45.000kg	1100317

Size : L-480mm, W-480mm, H-74mm

Capacity: 7000kg each having scale of $\pm 0^\circ - 60^\circ$

Material : Made from Cold Roll (CRC) Steel Sheet. Plastic Balls. (Ø18mm) used in Plastic cage.

Use : Used for easy turning of tyre left / right during alignment of Truck / Buses.

17 Mechanical Turn Table for Truck / Buses with Scale, Ramp & Centre Line

Dia (Top Plate):	Weight:	Code No.
480mm	63.390kg	1101117

Size : L-480mm, W-881mm, H-79mm

Capacity: 7000kg each having scale of $\pm 0^\circ - 60^\circ$

Material : Special Steel. Plastic Balls (Ø18mm) used in Plastic cage.

Use : Used for easy turning of tyre left / right during alignment of Truck / Buses. Ramp is made on Turn Table 1100317.

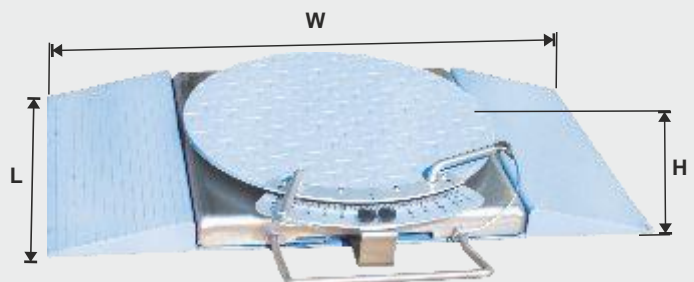

17 1101117



18 1105417 WHEEL ALIGNMENT TURN TABLE REBUILD KIT (STANDARD)

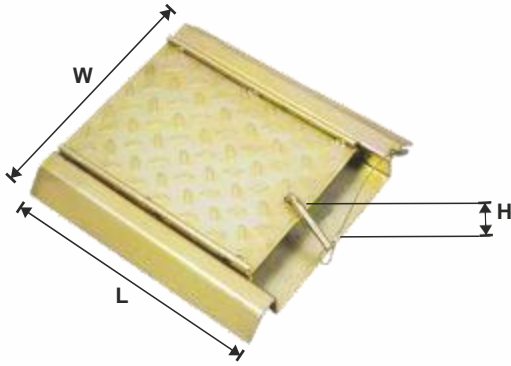

19 1130017

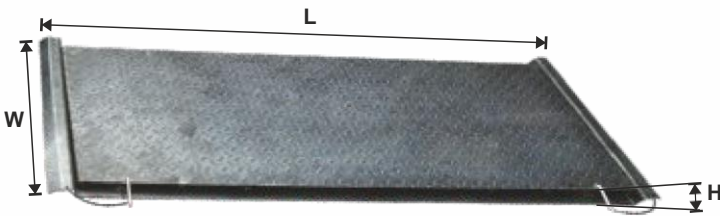

20 1168017



21 111184



21 111384



22 112184



22 112284



23 112384

18 Wheel Alignment Turn Table Rebuild Kit (Standard)

Weight:
455gms **Code No.**
1105417

The Kit contains the following items :

	Qty
• 9/16" Derlin Bearings	54 No.
• Stainless Steel Lock Pins	4 No.
• Retainer Rings with Spring assemblies	2 No.
• Steel Set Screws	2 No.
• Steel Top Screws	2 No.

Material : The Retainer Rings are made from Nylon Plastic.

Note : Retainer Ring Inner Dia : 5 7/8", Outer Dia : 7 3/4".

19 Rear Wheel Alignment Slip Plate

Top Plate Length: 300mm **Weight:** 9.000kg **Code No.** 1130017

Size : L-350mm, W-340mm, H- 50mm

Capacity: 1000kg each.

Material : Sheet Metal.

Use : Used for aligning the rear wheel of Passenger Car.

20 Rear Wheel Alignment Slip Plate

Top Plate Length: 1520mm **Weight:** 100.000kg **Code No.** 1168017

Size : L-1640mm, W-670mm, H- 50mm

Capacity: 2500kg each.

Material : Sheet Metal.

Use : Used for aligning the rear wheel of Passenger Car.

21 Brake Pedal Depressor

Length:	Weight:	Code No.
755mm	900gms	111184
740mm	915gms	111384

Use : Depresses brake while doing alignment. All metal parts are electroplated.

22 Steering Wheel Holder

Length:	Weight:	Code No.
430mm	1.210kg	112184
315mm	675gms	112284

Use : It securely holds the steering wheel in position when setting toe angle. Covered with soft Plastic to prevent damage to the steering wheel.

23 Steering Wheel Holder with Thumb Lock Release

Length:	Weight:	Code No.
300mm	695gms	112384

Use : It securely holds the steering wheel in position when setting toe angle. Works with a trigger controlled mechanism. Ergonomically designed with a thumb lock release.

Note : The Steering Wheel Holder 112384 is suitable for Car/Truck/Buses.

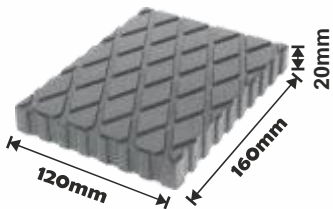

1 550204

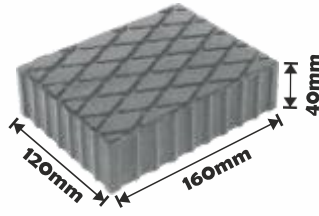

1 550004

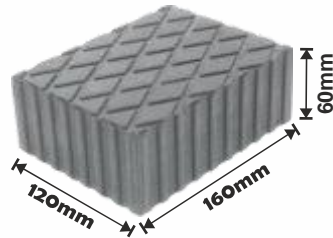

1 550604

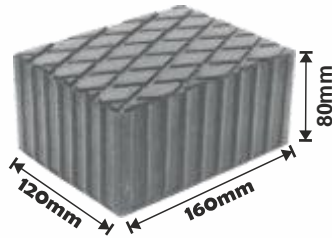

1 550804



1 553104

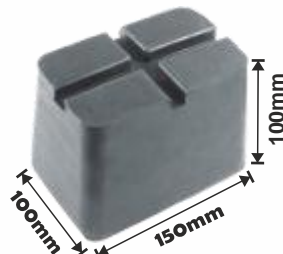

1 553204

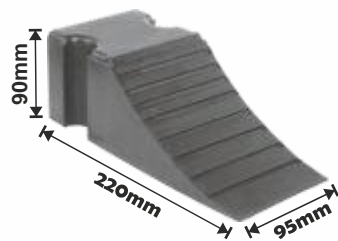

2 553004

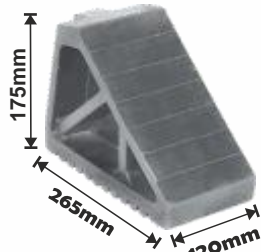

2 554504

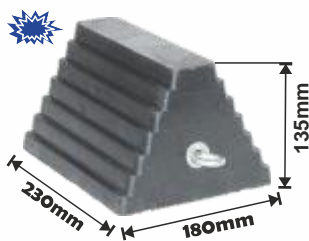

2 551904

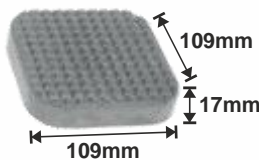

3 552004

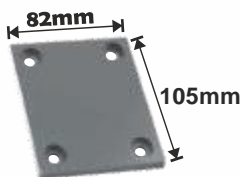

4 554304



5 554204



5 554004



5 555004



5 556004



5 552104MET



5 557004



5 557004TH



5 552204



5 552304

1 Rubber Pad for Passenger Car Lift

Size:	Weight:	Code No.
L-160mm, B-120mm, H-20mm	530gms	550204
L-160mm, B-120mm, H-40mm	1.080kg	550004
L-160mm, B-120mm, H-60mm	1.450kg	550604
L-160mm, B-120mm, H-80mm	1.940kg	550804
L-150mm, B-100mm, H-50mm	785gms	553104
L-150mm, B-100mm, H-100mm	1.600kg	553204

Use : Used at the time of lift of vehicle for Wheel Alignment and repairs. Durable & long lasting.

2 Rubber Wheel Chock

Size:	Weight:	Code No.
L-220mm, B-95mm, H-90mm	1.180kg	553004
L-265mm, B-120mm, H-175mm	3.650kg	554504
L-230mm, B-180mm, H-135mm	4.000kg	551904

Use : Ribbed Rubber Wheel Chock allows for ease of placement and drop-kick safety for Commercial Vehicles.

3 Rubber Pad for Passenger Car Jack

Size:	Weight:	Code No.
L-109mm, B-109mm, H-17mm	155gms	552004

4 Rubber Pad for Passenger Car Lifts

Size:	Weight:	Code No.
L-122mm, B-96mm, H-24mm	310gms	554404
L-145mm, B-145mm, H-12mm	315gms	555904
L-105mm, B-82mm, H-08mm	80gms	554304

5 Round Rubber Pad for Passenger Car Lifts

Dia:	Thickness:	Weight:	Code No.
123 mm	21mm	155gms	554204
127mm	25mm	230gms	554004
127mm	28mm	240gms	555004
140mm	16mm	320gms	556004
120mm(with steel plate)	10mm	290gms	552104MET
138mm	28mm	300gms	557004
138mm	28mm	300gms	557004TH
139mm	28mm	340gms	552204
144mm	20mm	265gms	552304

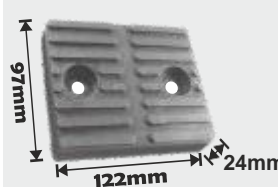

4 554404

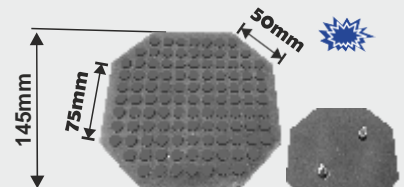

4 555904



6 552404



6 552504



6 552604



6 552604MET



6 552704



6 552704MET



6 552804



6 552904

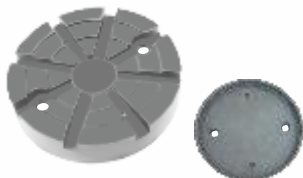

6 554104MET



6 554604



6 554704



6 554904



6 555104



6 555204

6 Round Rubber Pad for Passenger Car Lifts

Dia:	Thickness:	Weight:	Code No.
145mm	26mm	335gms	552404
120mm	27mm	220gms	552504
123mm	25mm	165gms	552604
123mm(with Steel plate)	25mm	300gms	552604MET
100mm	21mm	105gms	552704
100mm(with Steel plate)	21mm	170gms	552704MET
148mm	25mm	260gms	552804
123mm	23mm	200gms	552904
123mm(with Steel plate)	23mm	390gms	554104MET
120mm	32mm	320gms	554604
130mm	24mm	220gms	554704
125mm	26mm	225gms	554904
120mm	19mm	185gms	555104
100mm	21mm	110gms	555204
145mm	25mm	290gms	555304
123mm	22mm	145gms	555404
123mm	26mm	180gms	555504
140mm	27mm	300gms	555604
160mm	30mm	395gms	555704
120mm	19mm	150gms	555804

Use : Used at the time of lift of vehicle for Wheel Alignment and repairs. Durable and long lasting.



6 555304



6 555404



6 555504



6 555604



6 555704



6 555804

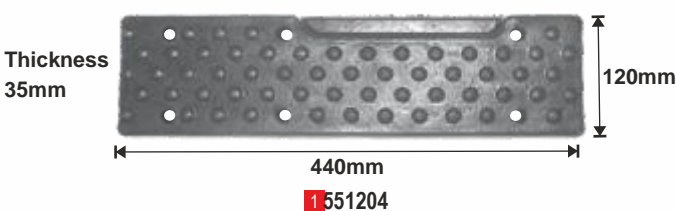
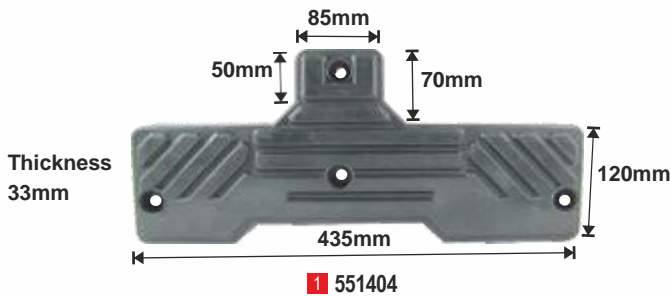
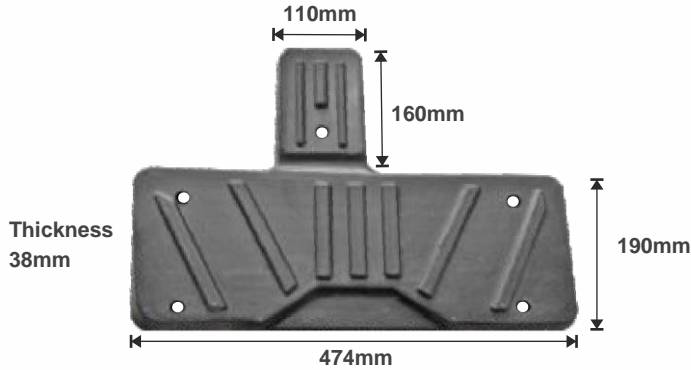
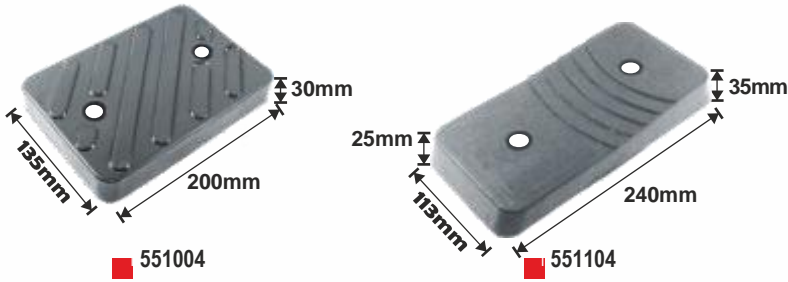

1 Bead Breaking Rubber Pad			
Weight:	Code No.	Weight:	Code No.
830gms	551004	890gms	558004
430gms	551104	2.095kg	551404
3.310kg	551804	1.620kg	551204
1.365kg	559004		
Use : Used with Tyre Changing Machines to prevent scratches on rims during bead breaking.			

2 Bead Breaking Pad	
Weight:	Code No.
1.310kgs	551304
Material : PU.	1.070kgs
	556204

3 Large Bead Loosener Front Pad (Nylon)	
Weight:	Code No.
250gms	551504

4 Small Bead Loosener Front Pad (Nylon)	
Weight:	Code No.
195gms	551704

5 Large Centre Rubber Pad	
Weight:	Code No.
1.195kgs	551604

6 Centre Rubber Pad	
Weight:	Code No.
0.923kgs	556104

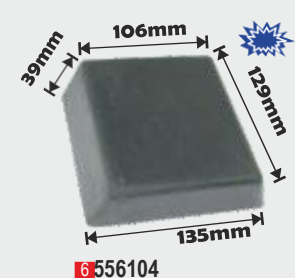
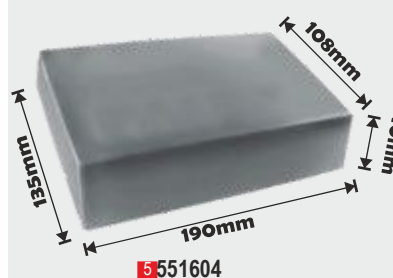
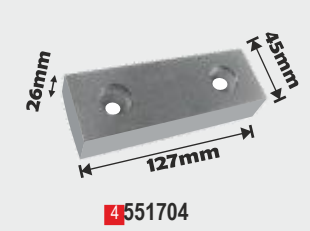
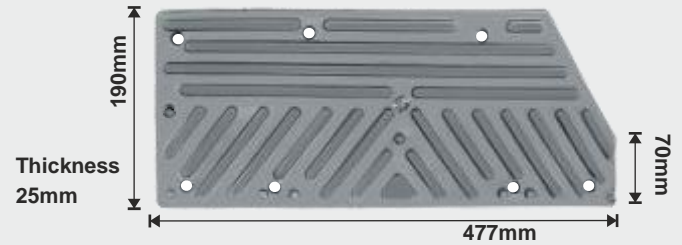



1 220057



2 220067



3 220077



3 220087



4 2224276



4 2227336



4 2230336



5 2200226



6 2200014



7 220025



7 220035



7 220045

1 Lug Nut Cap Puller

Size:
260mm long

Weight:
395gms

Code No.
220057

Material : Special Steel.

Finish : Electro Plating.

Use : A specialized tool to remove 32mm & 33mm Lug Nut Covers / Caps from Truck wheels.

2 Chrome Lug Nut Cover Puller (Heavy Duty)

Size:
285mm long

Weight:
500gms

Code No.
220067

Material : Special Steel.

Finish : Black colour.

Use : A specialized tool to remove 32mm & 33mm Lug Nut Covers / Caps from Truck wheels.

3 Screw Driver Handle with Hex

Size:
7mm Hex
7mm Hex

Weight:
75gms
60gms

Code No.
220077
220087

4 Double Ended Wheel Wrench for Trucks

Length:	Size:	Weight:	Code No.
400mm	24 X 27	2.200kg	2224276
400mm	27 X 32	2.200kg	2227326
400mm	30 X 32	2.310kg	2230326
400mm	24 X 33	2.250kg	2224336
400mm	27 X 30	2.200kg	2227306
400mm	27 X 33	2.200kg	2227336
400mm	30 X 33	2.300kg	2230336
400mm	21 X 41	2.300kg	2221416

Material : Chrome Vanadium / Carbon Steel.

Finish : Bright Nickel Chrome Plating / Black Powder Coating.

Use : Loosening & tightening of Truck wheel nuts.

5 Tommy Bar

Dia: 20mm
Size: 500mm long

Weight:
1.250 kg

Code No.
2200226

Material : Forged Chrome Vanadium Steel.

Finish : Black colour.

Use : Truck wrench handle heat-treated for strength and durability. Suitable for all  Truck Wrenches.

6 Four Way Wheel Nut Wrench for Trucks

Length: 570mm
Size: 24X27X32X3/4" square

Weight:
3.000kg

Code No.
2200014

Material : Forged Chrome Vanadium / Carbon Steel.

Finish : Bright Nickel Chrome Plating.

7 Four Way Wheel Nut Wrench for Passenger Cars

Length: 400mm
Size: 17X19X21X22
400mm 17X19X22X1/2" square
400mm 17X19X21X1/2" square

Weight:
1.415kg
1.420kg
1.355kg

Code No.
220025
220035
220045

Material : Forged Chrome Vanadium Steel / Carbon Steel with welded centers to achieve the desired strength.

Finish : Bright Nickel Chrome Plating / Black Powder Coating.

Use : Loosening & tightening of Passenger Car wheel nuts.



8 220714



9 222001



9 223001



9 224001



9 220404



10 220001



10 220002



10 220002S



10 225001

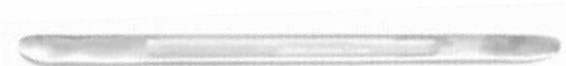

10 225101



10 225201



11 220008



12 226001



13 220003



14 2200012



15 220274



16 220284

8 Lever for Bicycles

Size:	Weight:	Code No.
110mm (4")	25gms	220714

Material : Nylon Plastic.

9 Tyre Lever

Size:	Weight:	Code No.
200mm (8")	240gms	222001
300mm (12")	385gms	223001
400mm (16")	630gms	224001
400mm (16")	375gms	220404

Material : Forged Chrome Vanadium Steel, hardened & tempered.

Finish : Sand Blasted surface with Nickel Chrome Plating.

Use : Used for Motorcycle / Scooter tyre service.

10 Tyre Lever

Type:	Size:	Weight:	Code No.
With Boot	500mm (20")	800gms	220001
---	500mm (20")	785gms	220002
---	500mm (20")	815gms	220002S
Thin Cross Sectional thickness of 7mm	500mm (20")	640gms	225001
---	500mm (20")	800gms	225101
Run Flat	500mm (20")	820gms	225201

Material : Forged Chrome Vanadium Steel, hardened & tempered.

Finish : Sand Blasted surface with Nickel Chrome Plating.

Use : Used for Passenger Car tyre service.

11 Tyre Lever

Size:	Weight:	Code No.
600mm (24")	930gms	220008

Material : Forged Chrome Vanadium Steel, hardened & tempered.

Finish : Sand Blasted surface with Nickel Chrome Plating.

12 Run Flat Lever

Size:	Weight:	Code No.
600mm (24")	865gms	226001

Material : Forged Chrome Vanadium Steel, hardened & tempered.

Finish : Sand Blasted surface with Nickel Chrome Plating.

13 Truck Tyre Lever with Crank End

Size:	Weight:	Code No.
610mm (24")	1.360kg	220003

Material : Forged Chrome Vanadium Steel, hardened & tempered.

Finish : Sand Blasted surface with Nickel Chrome Plating.

Use : Suitable for LCV, Trucks and large wheels, this tyre lever is extra heavy duty with crank end.

14 Lever for Removal of Locking Rings

Size:	Weight:	Code No.
470mm (18")	720gms	2200012

Material : Forged Chrome Vanadium Steel, hardened & tempered.

Finish : Sand Blasted surface with Nickel Chrome Plating.

Use : To remove locking rings of tube type tyres.

15 Rim Straightener Lever

Size:	Weight:	Code No.
390mm (15")	500gms	220274

Material : Special Steel.

Finish : Sand Blasted surface with Nickel Chrome Plating.

Use : Used for repairing of deformation on the rim flange.

16 Tubeless Truck Tyre Lever with Hook

Size:	Weight:	Code No.
675mm (26.6")	1.550kg	220284

Material : Forged Chrome Vanadium Steel.

Finish : Sand Blasted surface with Nickel Chrome Plating.

Use : Used for mounting on wide base rims.



17 220204



18 2202045



19 220304



20 220154



21 220164



22 220214



23 220194



24 220174



25 220184



26 220004



27 220244



28 220234



29 220224

17 Wheel Flange Loosener

Dia:	Size:	Weight:	Code No.
32mm	300mm long	2.060kg	220204

Material : Forged CV Steel, hardened & tempered. Black colour.

Use : Used for loosening rusted Truck and Bus Beads. Speeds up Truck tyre repair work and saves labour and time.

18 Wheel Flange Loosener with Plastic Hand Protection

Dia:	Colour:	Size:	Weight:	Code No.
32mm	Red	330mmx93mm	1.850kg	2202045
32mm	Blue	330mmx93mm	1.850kg	2202045S

Material : Forged CV Steel, hardened & tempered.

Finish : Sand Blasted surface with Nickel Chrome Plating.

Use : Used to loosen rusted Truck and Bus Beads. Speeds up Truck tyre repair work. Easy to handle.

19 Lever for Tube & Tubeless Truck Tyres

Size:	Weight:	Code No.
255mm long	500gms	220304

Material : Forged CV Steel, hardened & tempered. Black colour.

20 Special Lever for Motorcycle Tyres

Size:	Weight:	Code No.
390mm long	540gms	220154

Material : Forged CV Steel, hardened & tempered. Black colour.

21 Lever for Tubeless Tyres for Passenger Cars

Size:	Weight:	Code No.
390mm long	565gms	220164

Material : Forged CV Steel, hardened & tempered. Black colour.

22 Lever for Tube and Tubeless Truck Tyres

Size:	Weight:	Code No.
420mm long	810gms	220214

Material : Forged CV Steel, hardened & tempered. Black colour.

23 Lever for Tube and Tubeless Truck Tyres - mounted on Flat Rims

Size:	Weight:	Code No.
460mm long	1.050kg	220194

Material : Forged CV Steel, hardened & tempered. Black colour.

24 Lever for small size Tubeless Truck & Tractor Tyres - mounted on Drop-Centre Rims

Size:	Weight:	Code No.
530mm long	1.050kg	220174

Material : Forged CV Steel, hardened & tempered. Black colour.

25 Lever for big size Tubeless Truck & Tractor Tyres - mounted on Drop-Centre Rims

Size:	Weight:	Code No.
760mm long	1.630kg	220184

Material : Forged CV Steel, hardened & tempered. Black colour.

26 Lever for Tubeless Truck Tyre - mounted on 15° drop-centre rims

Size:	Weight:	Code No.
800mm long	1.950kg	220004

Material : Forged CV Steel, hardened & tempered. Black colour.

27 Lever for Lug Base and Earthmover Tyres - mounted on Drop-Centre Rims

Size:	Weight:	Code No.
940mm long	2.180kg	220244

Material : Forged CV Steel, hardened & tempered. Black colour.

28 Lever for Earthmover Tyres

Size:	Weight:	Code No.
965mm long	2.780kg	220234

Material : Forged CV Steel, hardened & tempered. Black colour.

29 Lever for Truck, Tractor / OTR Tyres

Size:	Weight:	Code No.
1400mm long	11.300kg	220224

Material : Forged CV Steel, hardened & tempered. Black colour.



30 220034



31 220054



32 220084



33 220254



34 220014



34 220024



35 220094



36 220264



37 220104



38 220124



39 220134



40 220814

30 Tyre Mount/Demount Iron for Small Tyres

Size:	Weight:	Code No.
420mm long	750gms	220034

Material : Forged CV Steel, hardened & tempered. Black colour.

Use : Used in pair to Mount/Demount small Passenger Car, Industrial, ATV and Motorcycle tyres.

31 Tyre Mount/Demount Spoon Drop Center

Size:	Weight:	Code No.
460mm long	890gms	220054

Material : Forged CV Steel, hardened & tempered. Black colour.

Use : Used to Mount/Demount Passenger Car, Motorcycle ATV and Light Truck tyres.

32 Rim Lock Tool

Size:	Weight:	Code No.
460mm long	810gms	220084

Material : Forged CV Steel, hardened & tempered. Black colour.

Use : Used for servicing 5° wide base rim.

33 Special Lever for Mercedes Car

Size:	Weight:	Code No.
560mm long	1.470kg	220254

Use : A special tyre lever used for Mercedes Car.

34 Tyre Mount/Demount Spoon

Type:	Size:	Weight:	Code No.
Curved	760mm long	1.470kg	220014
Straight	760mm long	1.475kg	220024

Material : Forged CV Steel, hardened & tempered. Black colour.

Use : Designed for easy and fast tyre changing. Used to provide good strength & leverage to work with large Trucks, Buses, Off Road vehicles, Tractors & Air Craft tyres.

35 Swan Neck Leverage Bar

Size:	Weight:	Code No.
760mm long	2.400kg	220094

Material : Forged CV Steel, hardened & tempered. Black colour.

Use : Used to remove frozen or rusted beads from all types of Truck / Farm / OTR rims.

36 Heavy Duty Lock Ring Tool

Size:	Weight:	Code No.
900mm long	1.900kg	220264

Use : Used for multi-piece wheels especially hub type.

37 Tubeless Tyre Straight Mount/Demount Iron

Size:	Weight:	Code No.
910mm long	2.000kg	220104

Material : Forged CV Steel, hardened & tempered. Black colour.

Use : Used for a variety of tyre changing applications.

38 Impact Bead Breaker

Size:	Weight:	Code No.
1170mm-1830mm long	6.500kg	220124

Material : Steel Pipe. Black colour.

Use : Used to easily loosen beads of the tyre with bead-breaking foot and ram bar but never cuts the bead of the tyre.

39 Impact Bead Breaker

Size:	Weight:	Code No.
1270mm-2030mm long	10.500kg	220134

Material : Steel Pipe. Black colour.

Use : Used to easily loosen beads of the tyre with bead-breaking foot and ram bar but never cuts the bead of the tyre.

40 Heavy Duty Mounting Lever for Tubeless Truck/Bus Tyre

Size:	Weight:	Code No.
1210mm long	3.400kg	220814

Material : Steel Pipe. Black colour.

Use : Used to easily loosen beads of the tyre with bead-breaking foot & ram bar but never cuts the bead of the tyre. Gives more leverage when mounting in a horizontal position on the ground.

**41 Trilex Lever for Tubeless Truck/ Bus Tyre**

Size: 1045mm long
Weight: 3.200kg

Code No.
221314

Material : CV Steel and Steel Pipe.

Use : A double mounting lever for 3 piece rims.

42 Demounting Lever for Tubeless Truck/ Bus Tyre

Size: 1780mm long
Weight: 6.500kg

Code No.
220314

Material : Casting and Steel Pipe.

43 Mounting Lever for Tubeless Truck/ Bus Tyre

Size: 1050mm long
Weight: 2.600kg

Code No.
220414

Material : Casting and Steel Pipe.

44 Mounting Lever for Tubeless Truck/ Bus Tyre

Size: 1040mm long
Weight: 2.950kg

Code No.
220514

Material : Casting and Steel Pipe. Powder Coating.

Use : This mounting lever is ideal for Aluminum rims.

45 Demounting Lever for Tubeless Truck/ Bus Tyre

Size: 1610mm long
Weight: 10.100kg

Code No.
220614

Material : Casting and Steel Pipe. Powder Coating.

Use : This demounting lever is ideal for Aluminum rims.

46 Demounting Lever for 17.5" Tubeless Truck/ Bus Tyre

Size: 1500mm long
Weight: 6.500kg

Code No.
221414

Material : Special Steel Casting. Powder Coating.

Use : Specialized lever for demounting 17.5" Truck / Bus tyre.

47 Rim Lock Ring Removal Tool

Size: 1050mm long
Weight: 3.500kg

Code No.
220914

Material : Casting and Steel Pipe. Powder Coating.

Use : Specialized wrench to remove single lock rings of Truck / Bus tyre rims after bead breaking.

48 Rim Lock Ring Fitting Tool

Size: 1230mm long
Weight: 2.950kg

Code No.
221014

Material : Forged CV Steel, hardened & tempered.

Use : Specialized wrench to fit rings of Truck / Bus tyre rims. Used in pair.

49 Wheel Cover Puller/Replacer

Size: 350mm long
452mm long
Weight: 610gms
820gms

Code No.
220011
220211

Material : Steel Rod.

Use : Removes wheel covers quickly and easily without damaging or scratching them. Rubber head prevents damage to the hub cap and is replaceable.

50 Rubber Mallet

Size: 420mm long
300mm long
Weight: 480gms
1.200kg

Code No.
220420
220430

Use : Rubber Head Mallet prevents damage to the rim surface.

51 Pump Ring Rigid for Tubeless Truck Tyre

Size: 22.5"
Weight: 11.000kg

Code No.
224222

Rubber Ring for Pump Ring Rigid

Weight: 3.500kg
Code No.
224222R

52 Pump Ring Flexible for LCV and HCV Tubeless Tyre

Sectional Dia:	Size:	Weight:	Code No.
25mm	15.5"	500gms	224215
25mm	17.5"	750gms	224217
25mm	22.5" to 24.5"	1.000kg	224224

Use : Used for sealing the tyre beads of the rims.



53 2201017



53 2200117



54 2200217



54 2200517



55 2200317



57 2200717



58 550005



56 2200417



59 224430



59 224432



59 224433



60 224232



60 224233



60 224332



60 224333



61 224232CH

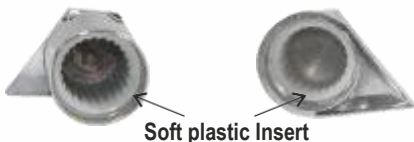

Soft plastic Insert



61 224332CH

53 Tyre Tread Depth Gauge (Plastic)

Size:	Weight:	Code No.
0 - 30mm	10gms	2201017
0 - 30mm	30gms	2200117

54 Tyre Tread Depth Gauge (Stainless Steel)

Size:	Weight:	Code No.
For Passenger Car tyre 0-50mm	30gms	2200217
For Truck tyre 0-90mm	85gms	2200517

55 OTR Tread Depth Gauge (Aluminum)

Size:	Weight:	Code No.
0 -150mm /	170gms	2200317
0-192 (32 NDS)		

Use : For measurement of Earthmover tyre tread depth. Supplied with case. Easy readability due to Glass lens.

56 OTR Tread Depth Gauge (Acrylic Plastic)

Size:	Weight:	Code No.
0-160mm /	55gms	2200417
0-192 (32 NDS)		

Use : For measurement of Earthmover tyre tread depth. Supplied with case.

57 Dial Type Tread Depth Gauge

Size:	Weight:	Code No.
0-110mm	80gms	2200717

58 Tool to Cancel Tyre Tread

Weight:	Code No.
110gms	550005

Material : Blades are made from Special Steel.

WHEEL PROTECT[®] Loose Wheel Nut Indicator

Size:	Code No.	Size:	Weight:	Code No.
17mm	224417	30mm	2gms	224430
19mm	224419	32mm	2gms	224432
21mm	224421	33mm	2gms	224433
24mm	224424	36mm	2gms	224436
26mm	224426	38mm	2gms	224438
27mm	224427	40mm	2gms	224440
		41mm	2gms	224441

Material : Special Durable Plastic.

Colour : Fluorescent Yellow, Red, Pink, Green, Orange.

Note : Customized colour can be provided for large orders.

60 Dust Cap & Loose Wheel Nut Indicator

Type:	Size:	Weight:	Code No.
Upper arrow	32mm	17gms	224232
Upper arrow	33mm	17gms	224233
Bottom arrow	32mm	17gms	224332
Bottom arrow	33mm	17gms	224333

Material : Special Durable Plastic.

Colour : Green, Red, Yellow, Pink.

Note : Customized colour can be provided for large orders.

61 Dust Cap & Loose Wheel Nut Indicator (Chrome Plated)

Type:	Size:	Weight:	Code No.
Upper arrow	32mm	60gms	224232CH
Upper arrow	33mm	60gms	224233CH
Bottom arrow	32mm	45gms	224332CH
Bottom arrow	33mm	45gms	224333CH

Material : ABS Plastic.

Colour : Chrome.



62 220203 MOTORCYCLE TOOL KIT

62 Mount/Demount Tool Kit for Motorcycle Tyre

Weight: 3.850kg
Code No. 220203

The Kit contains the following items:

Tool:	Qty:	Weight:	Code No.
• Bag	1 No.	315gms	220302
• Tyre Lever	3 No.	375gms	220404
• Ventifix with revolving Nozzle	1 No.	85gms	330043
• Sarv Paste (Economy)	1 No.	1.000kg	2200130
• Brush	1 No.	80gms	220515
• Rubber Mallet	1 No.	1.200kg	220430
• Valve Core Screw Driver	1 No.	25gms	330002
• Duster	1 No.	15gms	D0015



63 220403 STANDARD TOOL KIT

63 Tubeless Tyre Mount/Demount Standard ToolKit

Weight: 22.170kg
Code No. 220403

The Kit contains the following items:

Tool:	Qty:	Weight:	Code No.
• Bag with Wheels (optional)	1 No.	4.600kg	220412
• Tyre Lever	2 No.	1.950kg	220004
• Tyre Lever	1 No.	1.630kg	220184
• Impact Bead Breaker	1 No.	10.500kg	220134
• Bead Holding Tool	1 No.	350gms	220400
• Valve Core Screw Driver	1 No.	25gms	330002
• Sarv Paste (Economy)	1 No.	1.000kg	2200130
• Brush for Truck Tyre	1 No.	150gms	220415
• Duster	1 No.	15gms	D0015

Use : Mounts / Demounts all types of tubeless tyres 17.5" to 24.5".



64 220503 REGULAR TOOL KIT

64 Tubeless Tyre Mount/Demount Regular Tool Kit

Weight: 25.435kg
Code No. 220503

The Kit contains the following items:

Tool:	Qty:	Weight:	Code No.
• Bag with Wheels (optional)	1 No.	4.600kg	220412
• Mounting lever	1 No.	2.600kg	220414
• Demounting Lever	1 No.	6.500kg	220314
• Impact Bead Breaker	1 No.	10.500kg	220134
• Bead Holding Tool	1 No.	770gms	220500
• Valve Core Screw Driver	1 No.	25gms	330002
• Sarv Paste (Economy)	1 No.	1.000kg	2200130
• Brush for Truck Tyre	1 No.	150gms	220415
• Duster	1 No.	15gms	D0015

Use : Mounts all type of tubeless tyres 20" to 24.5". Demounts tyre in 8 seconds and remounts in 20 seconds. Works on standard and super single duplex tyres.



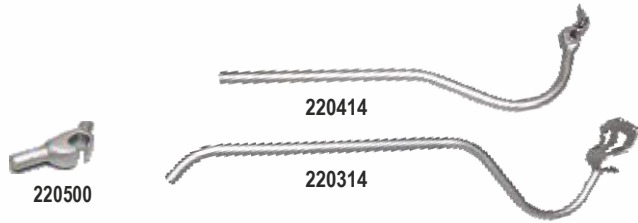

65 221503 REGULAR TOOL KIT

65 Tubeless Tyre Mount/Demount Regular Tool Kit

Weight: 9.870kg
Code No. 221503

The Kit contains the following items:

Tool:	Qty:	Weight:	Code No.
• Mounting Lever	1 No.	2.600kg	220414
• Demounting Lever	1 No.	6.500kg	220314
• Bead Holding Tool	1 No.	770gms	220500



66 220603 SMART TOOL KIT

66 Tubeless Tyre Mount/Demount Smart Tool Kit

Weight: 29.385kg
Code No. 220603

The Kit contains the following items:

Tool:	Qty:	Weight:	Code No.
• Bag with Wheels (optional)	1 No.	4.600kg	220412
• Mounting Lever	1 No.	2.950kg	220514
• Demounting Lever	1 No.	10.100kg	220614
• Impact Bead Breaker	1 No.	10.500kg	220134
• Bead Holding Tool	1 No.	770gms	220500
• Valve Core Screw Driver	1 No.	25gms	330002
• Sarv Paste (Economy)	1 No.	1.000kg	2200130
• Brush for Truck Tyre	1 No.	150gms	220415
• Duster	1 No.	15gms	D0015

Use : Mounts all type of tubeless tyres 20" to 24.5". Demounts tyre in 8 seconds and remounts in 20 seconds.



67 220905 TUBELESS TYRE MOUNT DEMOUNT TOOL KIT FOR 17.5" TYRES

67 Tubeless Tyre Mount/Demount Tool Kit for 17.5" Tyre

Weight: 25.400kg
Code No. 220905

The Kit contains the following items:

Tool:	Qty:	Weight:	Code No.
• Bag with Wheels (optional)	1 No.	4.600kg	220412
• Mounting Lever	1 No.	2.000kg	220104
• Demounting Lever	1 No.	6.500kg	221414
• Impact Bead Breaker	1 No.	10.500kg	220134
• Bead Holding Tool	1 No.	250gms	220513
• Valve Core Screw Driver	1 No.	25gms	330002
• Sarv Paste (Economy)	1 No.	1.000kg	2200130
• Brush for Truck Tyre	1 No.	150gms	220415
• Duster	1 No.	15gms	D0015

Use : Specifically designed to mount/demount 17.5" tyres without damaging the tyre bead and rim.





1 220118



1 220118F



1 226018



1 224518



2 220218



2 220218TB



2 222418



2 220518



2 220518P



2 220618



2 220618N

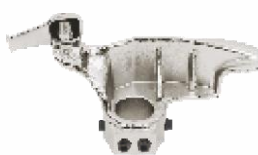

2 220718



2 226518



2 222518



2 222518J



2 220918



3 220918R



3 225018R



2 220818



2 226318



3 225118R



3 RUBRING

1 Tyre Mount/Demount Tool (Steel) for Automatic Tyre Changers for Motorcycles

Bore Dia:	Weight:	Code No.
28mm	460gms	220118
28mm	460gms	220118F
28mm	370gms	226018
28mm	435gms	224518

Material : Made out of Special Spring Steel. Nickel Plating.

2 Tyre Mount/Demount Tool (Steel) for Automatic Tyre Changers for Passenger Cars

Tapered Bore Dia:	Bore Dia:	Weight:	Code No.
-----	28mm	690gms	220218
24mm	31mm	690gms	220218TB
-----	28mm	550gms	222418
-----	29mm	600gms	220518
-----	29mm	615gms	220518P
29mm	33mm	580gms	220618
29mm	33mm	620gms	220618N
-----	28mm	600gms	220718
-----	28mm	600gms	226518
-----	28mm	600gms	222518
-----	28mm	600gms	222518J
-----	28mm	600gms	220818
-----	30mm	600gms	226318
-----	28mm	670gms	220918

Material : Made out of Special Spring Steel. Nickel Plating.

2 Tyre Mount/Demount Tool (Steel) with Rubber Ring for Automatic Tyre Changers for Passenger Cars

Tapered Bore Dia:	Bore Dia:	Weight:	Code No.
-----	28mm	685gms	220918R
28mm	30mm	617gms	225018R
28mm	30mm	617gms	225118R

Material : Made out of Special Spring Steel. Nickel Plating.

Rubber Ring for Tyre Mount/Demount Tool (Steel) with Collar

Size:	Weight:	Code No.
35mm	15gms	RUBRING

Note : RUBRING fits on Mount / Demount tools 220918, 220918R, 225018R, 225118R.



4 220318



4 221618

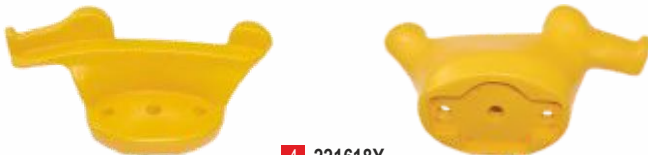

4 221618Y



4 226418



4 222218

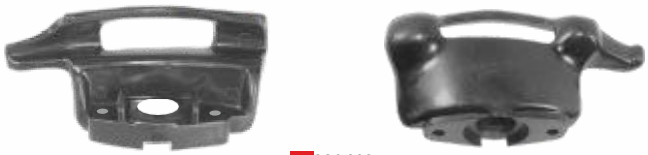

4 220418



4 221418RS



4 221418



14 222118



4 221818



4 221918

4 Tyre Mount/Demount Tool (Plastic) for Automatic Tyre Changers

Bore Dia:	Weight:	Code No.
28mm	175gms	220318
-----	155gms	221618
-----	155gms	221618Y
28mm	225gms	226418
28mm	195gms	222218
28mm	216gms	220418
-----	200gms	221418
Consumable Plastic part	12gms	221418RS
28mm	195gms	222118
-----	195gms	221818
28mm	215gms	221918

Material : Made from Special Blended Nylon Plastic (Nylon 66).
Use : Wearing Mount/Demount Tool Head protects tyre & rim from metal to metal contact damage. Using Plastic Mount/Demount Tool Head is much safer for delicate and expensive wheels yet durable enough to withstand the stress of larger tyres and wheels.
Note : The Consumable Plastic part 221418RS can be used on the Plastic Mount/Demount tools 221418 and 222118.

5 Wide Tool Head for Lever less Tyre Changers

Size:	Weight:	Code No.
L-142mm, W-74mm	194gms	222318

Material : Made from Special Blended Nylon Plastic (Nylon 66).

6 Tool Head for Lever less Tyre Changers

Size:	Weight:	Code No.
L-174mm, W-81mm	175gms	222818

Material : Made from Special Blended Nylon Plastic (Nylon 66).



5 222318



6 222818





7 225918



7 221718



7 221718Y



7 221518



7 222018



8 226718



8 228818



9 226718KIT



9 228818KIT

7 Tyre Mount/Demount Tool (Plastic) for Automatic Tyre Changers

Bore Dia:	Weight:	Code No.
28mm	210gms	225918
-----	185gms	221718
-----	185gms	221718Y
29mm	210gms	221518
29/30mm	195gms	222018

Material : Made from Special Blended Nylon Plastic (Nylon 66).

8 Tyre Mount/Demount Tool for (Plastic) Automatic Tyre Changers

Tapered Bore Dia:	Bore Dia:	Weight:	Code No.
25mm	30mm	151gms	226718
25mm	30mm	181gms	228818

Material : Made from Special Blended Nylon Plastic (Nylon 66).

9 Tyre Mount/Demount Tool (Plastic) with Hardware

Tapered Bore Dia:	Bore Dia:	Weight:	Code No.
25mm	30mm	198gms	226718KIT
25mm	30mm	260gms	228818KIT

Material : Made from Special Blended Nylon Plastic (Nylon 66).

10 Quick Change Kit

Weight:	Code No.
1.760kg	228918KIT

The 228918Kit contains the following items:

Tool:	Qty:	Weight:	Code No.
• Plastic Head with Quick Change Connector	1 No.	1.050kg	228918
• Connector	1 No.	710gms	228918C

11 Quick Change Adaptor

Bore Dia:	Weight:	Code No.
28mm	1.255kg	224418

Use : For quickly interchanging Metal & Plastic mount/demount tool heads.

12 Quick Change Kit

Weight:	Code No.
1.865kg	224418KIT

The Kit contains the following items:

Tool:	Qty:	Weight:	Code No.
• Quick Change Adaptor	1 No.	1.255kg	224418
• Plastic Head with Tool Holder	1 No.	610gms	224618

13 Quick Change Tool Holder Kit

Weight:	Code No.
1.647kg	225318KIT

The Kit contains the following items:

Tool:	Qty:	Weight:	Code No.
• Quick Change Adaptor	1 No.	1.255kg	224418
• Tool Holder	1 No.	392gms	224618TH

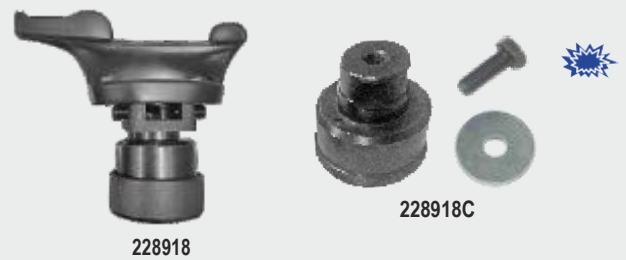

228918

228918C

10 228918KIT



11 224418



224618



224418

12 224418KIT



224418

13 225318KIT



224618TH



14 Tyre Mount/Demount Tool (Plastic) with Tool Holder

Tapered Bore Dia:	Bore Dia:	Weight:	Code No.	
-----	33mm	350gms	223618	
-----	28mm	730gms	223418	
-----	29/30mm	750gms	223018	
-----	29mm	700gms	223118	
-----	28mm	870gms	222918	
-----	28mm	685gms	223218	
-----	28mm	530gms	223718	
-----	28mm	556gms	223718FR	
-----	25mm	28mm	500gms	226218

Material : Made from Special Blended Nylon Plastic (Nylon 66).

15 Tool Holder for Plastic Mount/Demount Tools

Tapered Bore Dia:	Bore Dia:	Weight:	Code No.
-----	28mm	480gms	221318
-----	28mm	547gms	221318H
29mm	33mm	180gms	222618
-----	28mm	275gms	224718
-----	28mm	287gms	224718F
-----	29/30mm	400gms	225518
-----	28mm	475gms	223918
23mm	28mm	320gms	225818
-----	28mm	715gms	224818

Material : Made out of Special Steel.

Use : Tool Holders are fitted on various Plastic Mount / Demount Tools as per following code nos. :

Tool Holder:	Mount/Demount Tool:
221318	- Fits on 220318, 220418, 222118
221318H	- Fits on 220318, 220418, 222118
222618	- Fits on 221618, 221618Y
224718	- Fits on 221718, 221718Y
224718F	- Fits on 221718, 221718Y
224818	- Fits on 221918
225518	- Fits on 221518, 222018
223918	- Fits on 222218
225818	- Fits on 228818

16 Combo Tool

Size:	Weight:	Code No.
480mm	2.500kg	220116

Material : Durable Alloy Steel.

Finish : Sand Blasted Nickel Chrome Plated.

Use : Specially designed to mount/demount tyre effortlessly and damage free.

Plastic Inserts for Combo Tool

Size:	Weight:	Code No.
Small	11gms	221116
Big	21gms	222116

Material : Nylon 6

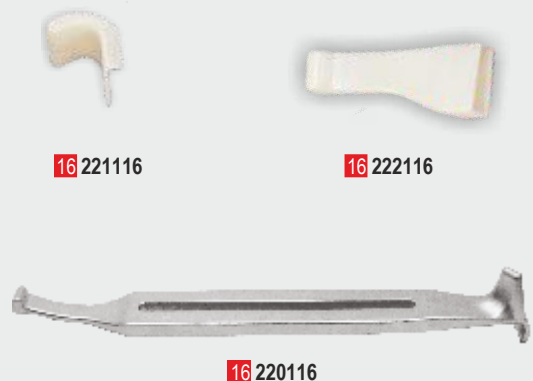



17 Plastic Inserts of Tyre Mount/Demount Tools

Colour:	Weight:	Code No.
Black	10gms	220028
Black	3gms	220828
White	3gms	221138
Black	3gms	221038
White	3gms	221338
Black	7gms	220628
Black	5gms	220328
Yellow	5gms	221738
Black	1gm	220428
Black	8gms	222638
Black	2gms	222738
Black	1gm	222838
Black	5gms	220228
Black	6gms	220728
Yellow	6gms	220728Y
Black	5gms	222938
Yellow	5gms	222938Y
Black	4gms	223138
Black	3gms	220838
Black	6gms	220438
Black	17gms	220638
Black	2gms	220338
Yellow	2gms	221938
Yellow	3gms	221838
White	3gms	221838WH
White	2gms	223238
Black	4gms	221028
White	2gms	222038
White	2gms	222138
White	2gms	222238
Black	4gms	220538
Yellow	7gms	222338
Black	4gms	220528
Yellow	5gms	221238
Black	3gms	220938
Yellow	3gms	221438
Black	3gms	220928
Yellow	3gms	220928Y
White	1gm	223438
White	6gms	223538
White	2gms	223638
White	9gms	223338
Silver	1gm	SCRM4X6
Yellow	3gms	222438
Yellow	6gms	222538

Material : Made from Special Durable Plastic (Nylon 6).





18 220738



19 221538



19 221638



19 223038



19 223038Y



20 2200121



20 2200221



20 2200321



20 2200321F



20 2200921



20 2201321



20 2202321



20 2200721



20 2200721Y



20 2200821



20 2200621



20 2201921



20 2201821

18 Mounting Head Protector

Colour:	Weight:	Code No.
Black	15gms	220738
Yellow	20gms	221538
Black	20gms	221638

Material : Special Plastic.

19 Jaw Protection Insert

Colour:	Weight:	Code No.
Black	3gms	223038
Yellow	3gms	223038Y

Material : Special Plastic.

Use : These inserts snap into place on the sloped surface of the metal tyre changing Jaw assembly. Helps to reduce metal to metal contact between the wheel rim and tyre changing Jaw.

20 Plastic Jaw Covers for Clamping Aluminum Alloy Rims

Colour:	Weight:	Code No.
Black	35gms	2200121
Black	35gms	2200221
Black	35gms	2200321
Black	30gms	2200321F
Black	50gms	2200921
Black	40gms	2201321
Black	27gms	2202321
Black	25gms	2200721
Yellow	25gms	2200721Y
Black	45gms	2200821
Black	80gms	2200621
Black	45gms	2201921
Black	35gms	2201821
Black	17gms	2201521
Black	20gms	2202021
Black	12gms	2201721
Black	17gms	2201021
Yellow	17gms	2201021Y
Yellow	22gms	2201221

Angled Jaw Cover

Angled Jaw Cover

Use : Used as the Jaw cover of Jaws of T/C Machines.

21 Slide Jaw Protector

Colour:	Weight:	Code No.
Yellow	60gms	2201421

Material : Engineering Plastic.



20 2201521

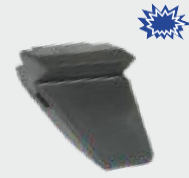

20 2202021



20 2201721



20 2201021



20 2201021Y



20 2201221



21 2201421



22 221048



23 221548



24 221648



25 221748



26 221848



27 220448



27 220448GR



220448WH



222248



27 220648



27 220848



27 220948



27 222348



27 220348



27 220348Y



27 221148

22 Bead Removal Tool for Lever Less Tyre Changing Machines

Colour:	Weight:	Code No.
Yellow	60gms	221048
Red	60gms	221048R

Material : Engineering Plastic. Glass filled for good strength and durability.

23 Rubber Tulip Pad

Colour:	Weight:	Code No.
Black	155gms	221548

Use : Mounted at the end of the arms that clamps the rim and prevent damage to the rim while providing grip to rotate the rim.

24 External Rubber Clamping Jaw

Colour:	Weight:	Code No.
Black	536gms	221648

Use : They work with machine which have hollow center of the tulip arms. If there is no hole on the top of the arms then these are not right parts to use.

25 Support Plate Cover

Colour:	Dia:	Weight:	Code No.
Black	240mm	149gms	221748

Material : Rubber.

Use : It protects the rim while servicing the reverse wheels. Should be removed if not servicing the reverse wheels.

26 Feeler Pin

Colour:	Size:	Weight:	Code No.
Grey	150mm long	20gms	221848

Material : Special Plastic.

27 Bead Breaker Blade Protection

Weight:	Code No.	Weight:	Code No.
82gms	220448	72gms	220948
82gms	220448GR	87gms	222348
82gms	220448WH	100gms	220348
60gms	222248	100gms	220348Y
88gms	220648	151gms	221148
94gms	220848	225gms	220548

Material : Engineering Plastic.

Use : Prevents metal to metal contact when bead loosening low profile tyres on expensive alloy wheels thereby preventing damage to the wheel.

28 Cone Cover

Colour:	Dia:	Weight:	Code No.
Black	45-130mm	165gms	221448
Yellow	40-125mm	46gms	221348
Yellow	28-120mm	60gms	222148

Material : Nylon.

Use : Protective Plastic cover that snaps securely over the wheel hold down cone to prevent damage to the wheel.



27 220548



28 221448



28 221348



28 222148



29 2200021



29 2201621



30 2200421



30 2200521



31 2201121



32 220039



33 220688

29 Clamping Jaws for Passenger Car Tyre Changers

Weight:	Code No.
115gms	2200021
180gms	2201621

Material : Made from Special Steel, hardened and tempered for longer life and durability.

Use : Four Jaws are required per machine for keeping the Jaw alignment even.

30 Clamping Jaws for Passenger Car Tyre Changers

Weight:	Code No.
230gms	2200421
230gms	2200521

Material : Special Carbon Steel, hardened and tempered for longer life and durability.

Use : Four Jaws are required per machine for keeping the Jaw alignment even.

31 Jaw Guide

Weight:	Code No.
650gms	2201121

Material : CRC Sheet.

Use : Used in a set of four pieces to increase or decrease the rim clamping size.

32 Motor Cycle Adaptor Kit

Size:	Weight:	Code No.
120mm x 50mm	915gms	220039

Material : CRC Sheet.

Use : The kit of 4 Clamps and protectors fits most rim clamp tire changers. Allows standard Tire Changing Machine to grip Motorcycle wheels. Lifts spoked wheels away from Turn Table. Easy to set up and remove.

33 Screw Knob

Weight:	Code No.
270gms	220688

Use : Used for arm adjusting for Passenger Car Tyre Changers.

34 Scissor

Dia:	Weight:	Code No.
65mm	3.000kg	220088

Material : CRC Sheet.

Use : Used for the movement of the Jaws on the Turn Table.



34 220088



35 220009



Ribs

36 220019



Ribs

36 220019Y



Plain

36 220019



37 2200010



37 2200110



37 2200210



37 2200310



37 2200410



38 2200410PU

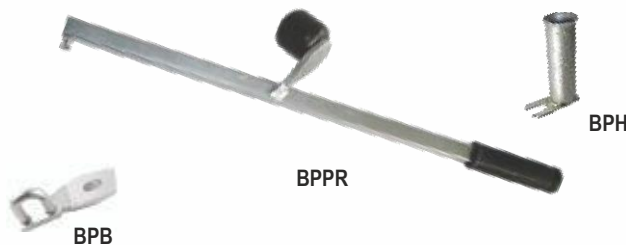

39 2200411 Bead Pressing Tool Kit

35 Tyre Lever Boot Short

Weight:
11gms

Code No.
220009

Material : Nylon-6.

Use : Plastic protection for light metal rims used with tyre levers 220001 and 220002.

36 Tyre Lever Boot Long

Colour:
Black (Ribbed end)
Yellow (Ribbed end)
Black (Plain end)

Weight:
60gms
60gms
58gms

Code No.
220019
220019Y
220119

Material : Nylon-6.

Use : Plastic protection for light metal rims used with tyre levers.

37 Rim Protector

Colour: White, Black, Red, Blue, Yellow
Size: 150mm long, 150mm long, 150mm long, 150mm long, 150mm long

Weight: 35gms, 35gms, 35gms, 35gms, 35gms

Code No. 2200010, 2200110, 2200210, 2200310, 2200410

Material : Nylon-6.

Use : Used to clip over an alloy wheel to reduce scratching along wheel.

38 Rim Protector PU

Colour: Yellow
Size: 150mm long

Weight: 40gms

Code No. 2200410PU

Material : Made from Poly Urethane (PU).

Use : Used to clip over an alloy wheel to reduce scratching along wheel.

39 Bead Pressing Tool Kit

Weight:
1.475kg

Code No.
2200411

The Kit contains the following items:

Tool:	Qty:	Weight:	Code No.
• Bead Presser with Plastic Roller	1 No.	890gms	BPPR
• Bead Presser Holder	1 No.	365gms	BPH
• Bead Presser Bracket	1 No.	220gms	BPB

Material : MS Pipe.

Use : Used to clip over an alloy wheel to reduce scratching along wheel.

40 Bead Holding Rope

Size:
990mm long
1190mm long

Weight:
455gms
655gms

Code No.
2200511
2200611

Material : SS wire and Nylon Blocks with Steel Bush.

Use : Keeps Passenger Car tyre bead from slipping during mounting of top. Holds the Bead in 6 positions in the drop center.



40 2200511



40 2200611



41 220515



42 220415



42 220615



43 220715



44 220815



45 220915



46 2200015



46 2200115



47 221015



47 221115

41 Special Brush for Tyres with Wooden Handle for Passenger Cars & Trucks

Size (Handle):	Dia.	Weight:	Code No.
290mm long	25mm	80gms	220515

Use : Used to lubricate tire beads when mounting or removing tires.

42 Special Brush for Tyres with Wooden Handle for Trucks & Earthmovers

Size (Handle):	Dia.	Weight:	Code No.
300mm long	50mm	150gms	220415
230mm long	50mm	180gms	220615

Use : Used to lubricate tire beads when mounting or removing tires.

43 Brush for Tyres with Plastic Handle

Size (Handle):	Weight:	Code No.
170mm long	75gms	220715

Use : Used to lubricate tire beads when mounting or removing tires.

44 Brush for Tyres with Lid and Wooden Handle

Size (Handle):	Weight:	Code No.
160mm long	65gms	220815

Use : Used to lubricate tire beads when mounting or removing tires.

45 Angled Applicator Brush for Tyres with Wooden Handle

Size (Handle):	Weight:	Code No.
210mm long	95gms	220915

Use : Used to lubricate tire beads when mounting or removing tires.

46 Special Brush for Tyres

Size (Handle):	Handle:	Weight:	Code No.
160mm long	Wooden	100gms	2200015
160mm long	Plastic	80gms	2200115

Use : Used to lubricate tire beads when mounting or removing tires.

47 Special Brush for Tyres with Wooden Handle

Size (Handle):	Dia.	Weight:	Code No.
340mm long	25mm	47gms	221015
340mm long	50mm	68gms	221115

Use : Used to lubricate tire beads when mounting or removing tires.

48 Sarv Paste (Economy)

Colour:	Weight:	Code No.
White	1kg	2200130
White	4kg	2200430
White	5kg	2200530

Use : Quick drying, non greasy tyre paste. Used for lubricating tyre beads in mounting & demounting operations.

49 Lube Bucket

Colour:	Weight:	Code No.
Red	188gms	2200630

Material : Special Plastic



49 2200130



49 2200430



49 2200530



49 2200630

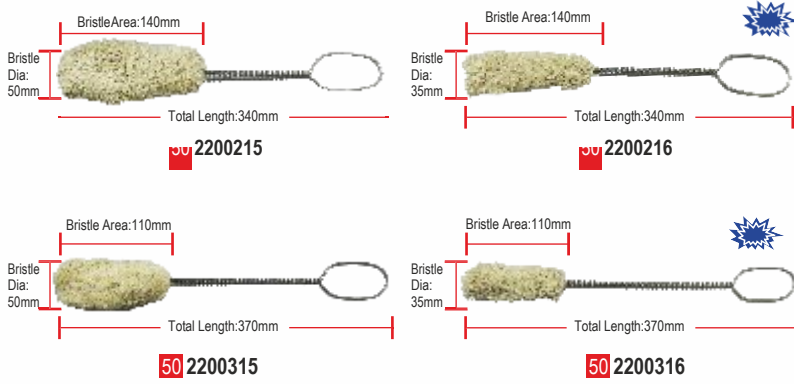

50 Swab

Standard	Weight: 100gms	Code No. 2200215
Standard (Thinner)	80gms	2200216
Long	110gms	2200315
Long (Thinner)	85gms	2200316

Use : Used to lubricate tyre beads while removing or mounting tyres on rims.

51 Tyre Mounting Aid

Weight: 310gms	Code No. 2200011
----------------	------------------

Material : Nylon-6

Use : Holds tyre bead below the rim flange for fast and damage free tyre mounting. Fits on all Passenger Car rims. Will not scratch decorative/Aluminum rims.



52 Tyre Mounting Aid (Supplied with Base 3)

Weight: 385gms	Code No. 2200311
----------------	------------------

Material : Nylon-6

Use : Holds tyre bead below the rim flange for fast and damage free tyre mounting. Fits on all Passenger Car rims. Will not scratch decorative/Aluminum rims.

Base : For Tyre Mounting Aid 2200311

Base 3 :	Size: 20mm	Weight: 85gms	Code No. 2200311C
----------	------------	---------------	-------------------



53 Tyre Mounting Aid

Weight: 300gms	Code No. 2200211
----------------	------------------

Material : Nylon-6

Use : Holds tyre bead below the rim flange for fast and damage free tyre mounting. Fits on all Passenger Car rims. Will not scratch decorative/Aluminum rims.

Base : For Tyre Mounting Aid 2200211 (optional)

	Size:	Weight:	Code No.
Base 1 :	44mm	165gms	2200211A
Base 2 :	20mm	80gms	2200211B

Use : Base 1 and Base 2 are used for increasing the base height and are optional to use.



54 Rim Clamp for Truck Tyre Changers

Weight: 1.600kg	Code No. 2200013
-----------------	------------------

Material : Special Steel Chrome plated to prevent corrosion.

Use : Clamps on wheel to prevent tyres from slipping.

55 Rim Clamp for Truck Tyre Changers

Weight: 1.750kg	Code No. 2200113
-----------------	------------------

Material : Special Steel Chrome plated to prevent corrosion.

Use : Clamps on wheel to prevent tyres from slipping.

56 Rim Clamp for Tubeless Truck Alloy Rims

Weight: 1.700kg	Code No. 2200313
-----------------	------------------

Material : Special Steel Chrome Plated to prevent corrosion.

Use : Clamps on wheel to prevent tyres from slipping.



57 Truck Tyre Bead Holder

Weight: 95gms	Code No. 220213
---------------	-----------------

Material : Made from indestructible Polymers Nylon-66.

Use : Keeps Truck tyre bead from slipping during mounting of top bead. Two bead holders are used simultaneously. No need to stand on tyre to mount.

58 Truck Tyre Bead Holder

Material:	Weight:	Code No.
CRC Sheet	350gms	220400
MS Casting	770gms	220500
MS Casting	250gms	220513

Use : The bead holder locks onto the flange of the wheel and holds tyre bead in place to eliminate standing on the tyre or changing the bead around the wheel.



1 330001



2 330002



2 330002BLU



3 3300012



3 3300012BLU



4 3300014



4 3300014BK



5 3300114



6 3300214



7 3300314

 $\tau=0.4 \text{ Nm}$

8 3300414



9 3300015



9 3300035



10 3300215

1 Valve Core Screw Driver double ended 1" stem length (VG5/Caps)

Weight:	Code No.
35gms	330001

Material : Carbon Steel and Plastic handle.**Use :** Removing & fixing valve cores in Passenger Cars and Trucks. Large and standard bore.**2 Valve Core Screw Driver standard single ended 1" stem length**

Colour:	Weight:	Code No.
Red	25gms	330002
Blue	25gms	330002BLU

Material : Carbon Steel and Plastic handle.**Use :** Removing & fixing valve cores.**3 Valve Core Screw Driver double ended 1" stem length (VG5/VG8)**

Colour:	Weight:	Code No.
Red	35gms	3300012
Blue	35gms	3300012BLU

Material : Carbon Steel and Plastic handle.**Use :** Removing & fixing valve cores, VG5 from one end and VG8 from the other end.**4 Valve Core Screw Driver standard single ended 1" stem length**

Colour:	Weight:	Code No.
Red	20gms	3300014
Black	20gms	3300014BK

Material : Carbon Steel and Plastic handle.**Use :** Removing & fixing valve core VG5.**5 Valve Core Screw Driver standard single ended 1.5" stem length**

Weight:	Code No.
20gms	3300114

Material : Carbon Steel and Plastic handle.**Use :** Removing & fixing Valve Core VG5.**6 Valve Core Screw Driver standard single ended 4" stem length**

Weight:	Code No.
30gms	3300214

Material : Carbon Steel and Plastic handle.**Use :** Removing & fixing Valve Cores VG5 from remote distance.**Valve Core Screw Driver (VG5/VG8)**

Weight:	Code No.
35gms	3300314

Material : Carbon Steel & Plastic handle. Metal part is Nickel Chrome Plated.**8 Valve Core Screw Driver 2" Stem Length with Torque**

Weight:	Code No.
40gms	3300414

Torque : Pre-set tightening torque 0.4 Nm.**Material :** Carbon Steel & Plastic handle. Metal part is Nickel Chrome Plated.**Use :** Prevents over screwing of the core while removing & fixing.**9 Cable Type Valve Fishing Tool**

Length:	Weight:	Code No.
215mm	35gms	3300015
300mm	40gms	3300035
600mm	60gms	3300065

Material : Carbon Steel.**Use :** Tool for easy valve installation in tubeless tyres.**10 Rigid Plastic Extensions**

Total Length:	Weight:	Code No.
115mm	7gms	3300215
125mm	9gms	3300125

Use : Mainly used to lengthen the valves on Trucks.



11 330003



11 330003BLU



12 330043



13 330073



14 330004



14 330024



15 330083

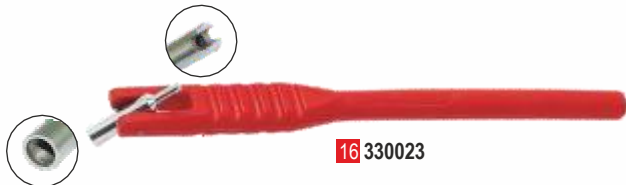

16 330023



16 3300223



17 330007



17 330008



18 330009



18 330029

11 Ventifix Plastic

Colour:	Weight:	Code No.
Green	75gms	330003
Blue	75gms	330003BLU

Material : Polyamide-6 for imparting super bending strength to the lever.

Finish : All metal parts are Nickel Chrome Plated.

Use : For mounting Rubber snap-in valves on Passenger Car. Protects light metal alloy rims from scratch.

12 Ventifix Plastic with Revolving Nozzle

Colour:	Weight:	Code No.
Red	85gms	330043

Material : Polyamide-6 for imparting super bending strength to the lever.

Use : For removing tubeless Motorcycle valves.

13 Ventifix Plastic with Valve Core Screw Driver at End

Colour:	Weight:	Code No.
Green	75gms	330073

Material : Polyamide-6 for imparting super bending strength to the lever.

Use : For mounting Rubber snap-in valves on Passenger Car & to open valve core screw.

14 Ventifix Steel

Colour:	Material:	Weight:	Code No.
Silver	Carbon Steel	300gms	330004
Silver	Steel Sheet	150gms	330024

Use : Ruggedly constructed Steel tool is designed to provide sure grip and leverage necessary for positioning seating or removal of snap-in type valves. Deep thread head assures ease of valve stem attachment.

15 Ventifix Aluminum

Colour:	Weight:	Code No.
Golden	242gms	330083

Use : Specially designed tool for insertion / remove of all kind of valves. Suitable for TPMS valves. The Rubber and Nylon pad prevents scratching of the wheel rim.

16 Ventifix Plastic (Heavy Duty)

Colour:	Weight:	Code No.
Red	95gms	330023
Black	95gms	3300123
Yellow	95gms	3300223

Material : Polyamide-6 for imparting super bending strength to the lever.

Use : For mounting Rubber snap-in valves on Passenger Car & to open valve core screw. Multiple ridges help keep the tool in place on wheels with different sizes.

17 Valve Extension Holder-Double Strip Type

Colour:	Size:	Weight:	Code No.
Golden	8mm	35gms	330007

Material : Carbon Steel and Spring Steel Wire.

Finish : Zinc Plated.

18 Valve Extension Holder-Double Clip Type

Colour:	Size:	Weight:	Code No.
Golden	16mm	60gms	330008

Material : Carbon Steel and Spring Steel Wire.

Finish : Zinc Plated.

19 Valve Extension Holder-Single Clip Type

Colour:	Size:	Weight:	Code No.
Golden	16mm	55gms	330009
Golden	26mm	60gms	330029

Material : Carbon Steel and Spring Steel Wire.

Finish : Zinc Plated.

Use : To secure position of flexible valve extensions.

**20 Valve Core Screw Driver**

Size:	Weight:	Code No.
1"	15gms	3300021
2"	40gms	3300061
4"	42gms	3300041
5"	45gms	3300051
10"	60gms	3300101

Material : Carbon Steel with Aluminum handle.

21 Valve Core Screw Driver Flexible

Size:	Weight:	Code No.
6"	46gms	3300611
8"	60gms	3300011
10"	65gms	3301011

Material : Carbon Steel and flexible Steel Wire rope with Aluminum handle.

Use : This Valve Core Screw Driver holds the valve core with a clip. Also the fitting / removing of valve cores is much easier.

22 Valve Core Screw Driver with Magnet

Size:	Weight:	Code No.
4"	45gms	3300541

Material : Carbon Steel. Magnet on the top of handle provides easy picking of valve core.

23 Valve Core Screw Driver For OTR Tyres

Size:	Weight:	Code No.
4"	100gms	3300441

Material : Carbon Steel with Aluminum handle.

24 Valve Cap Screw Driver For OTR Tyres

Weight:	Code No.
120gms	3300641

Material : Special Steel.

25 Tubeless Valve Stem Puller

Colour:	Handle Material:	Weight:	Code No.
Red	Aluminum	150gms	330006
Black	Steel	265gms	330026
Blue	Steel	310gms	330036
Black	Steel	275gms	330046
Green	Steel	275gms	330056

Use : Installs and removes tubeless valves in seconds and protects the expensive alloy rim from scratch. Metal tip helps push out old snap in valve. All handles are PVC coated for hand protection.

26 Tubeless Valve Stem Puller (Heavy Duty)

Weight:	Code No.
400gms	3300018

Material : Made out of Carbon Steel Strip.

Finish : Nickel/Zinc plated to prevent rusting.

Use : Heavy duty Pull a Stem Tool to pull old or insert new tubeless Rubber valve of all sizes.

27 Heavy Duty 4 Way Valve Core Repair Tool

Finish:	Material:	Weight:	Code No.
Auto black	Carbon Steel	25gms	3300115
Zinc plated	Special Steel	20gms	3300116

Use : Repairs and reconditions inside and outside Valve threads and removes broken cores.



27 3300115

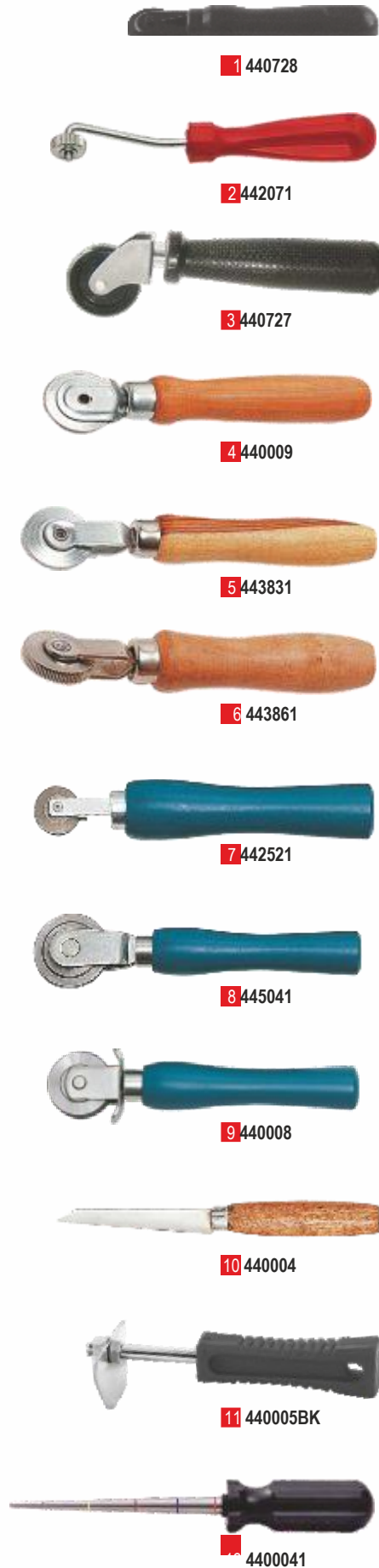

27 3300116

**1 Sticher Serrated Plastic**

Thickness:	Dia:	Weight:	Code No.
4mm	28mm	30gms	440728

Material : Nylon Plastic.

2 Sticher Serrated Plastic Handle

Thickness:	Dia:	Weight:	Code No.
7mm	20mm	75gms	442071

3 Special Sticher for Mushroom Kit

Thickness:	Dia:	Weight:	Code No.
9mm	35mm	85gms	440727

4 Sticher Economy Serrated Wooden Handle

Thickness:	Dia:	Weight:	Code No.
3mm	35mm	110gms	440009

5 Sticher Serrated Wooden Handle

Thickness:	Dia:	Weight:	Code No.
3mm	38mm	135gms	443831

6 Sticher Serrated Wooden Handle

Thickness:	Dia:	Weight:	Code No.
6mm	38mm	160gms	443861

7 Sticher Serrated Wooden Handle

Thickness:	Dia:	Weight:	Code No.
2mm	25mm	105gms	442521

8 Sticher Serrated Wooden Handle

Thickness:	Dia:	Weight:	Code No.
4mm	50mm	200gms	445041

9 Sticher Smooth Wooden Handle

Thickness:	Dia:	Weight:	Code No.
10mm	40mm	195gms	440008

10 Flexible Skiving Knife

Weight:	Code No.
50gms	440004

11 Hoe Style Inner Liner Scraper

Colour:	Weight:	Code No.
Blue	120gms	440005
Black	120gms	440005BK

Use : For cleaning the inner liners for both puncture and section repair prior to buffing.

12 Tyre Injury Measuring Tool

Weight:	Code No.
95gms	4400041

Use : A special tool used for measuring tyre injury varying from 3mm to 15mm.

13 Tyre Probe

Handle:	Size:	Weight:	Code No.
Wooden	100mm long	110gms	4400021
Plastic	100mm long	65gms	4400031

Use : For verifying damages, course of injuries and removing small foreign objects from the tyre tread.



13 4400021

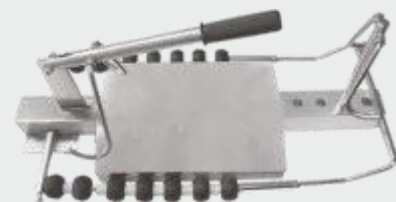

13 4400031

**14 Milling Cutter (High Speed Steel)**

Blade Length :	Total Length:	Dia:	Weight:	Code No.
30mm	60mm	3mm	3gms	4400317
50mm	110mm	4mm	5gms	4400417
30mm	90mm	6mm	16gms	4400017
45mm	80mm	6mm	18gms	4400617
45mm	75mm	6mm	16gms	4401617
50mm	110mm	6mm	20gms	4402617
50mm	110mm	8mm	40gms	4400817
60mm	110mm	8mm	40gms	4401817
40mm	110mm	9mm	45gms	4400917
50mm	110mm	9mm	45gms	4401917
64mm	115mm	10mm	55gms	4401017
72mm	120mm	13mm	95gms	4401317

Use : For the precise injury preparation on radial and cross-ply tires.

15 Milling Cutter in Screw Driver Handle

Blade Length:	Dia:	Weight:	Code No.
50mm	6mm	30gms	4403617
45mm	6mm	30gms	4404617

Material : High Speed Steel.

Use : The screw driver handle encloses the Angular Milling Cutter to be used manually.

Note : Angular Milling Cutter 4402617 is used in code No. 4403617.
Angular Milling Cutter 4400617 is used in code No. 4404617.

16 Marking Chalk

Colour:	Size:	Box Weight:	Code No.
White	80mm long	160gms	TMCHALKW
Yellow	80mm long	160gms	TMCHALKY

Note : 10 pieces packed in one box.

17 Rasp

Blade Length:	Dia:	Weight:	Code No.
40mm	38mm	48gms	440627

Use : Used to remove & grind away ribs inside the tyre prior to puncture repair.

18 Tyre Spreader

Length:	Weight:	Code No.
235mm	55gms	4400320
330mm	90gms	4400420

Material : Plastic.

Use : Used in pair to open the beads of tyre.

19 Tyre Bench Spreader

Size:	Weight:	Code No.
L-431mm, W-101mm, H-101mm	3.600kg	4400020
L-457mm, W-127mm, H-254mm	5.600kg	4400120

Material : CRC Steel.

Use : Tyre spreader is used for preparing the inspection and repair of Car and Truck tyres.

20 Tyre Bench Spreader

Size:	Weight:	Code No.
L-600mm, W-290mm, H-250mm	6.500kg	4400220

Material : CRC Steel.

Use : Holds the tube & provides a smooth base for processing. Spreads Car & Motorcycle tyres. Can be mounted on work bench. Suitable for very long stiff beads. High stability and strength.



21 4400010KIT



22 4400011KIT



23 4400010H

23 4400011H

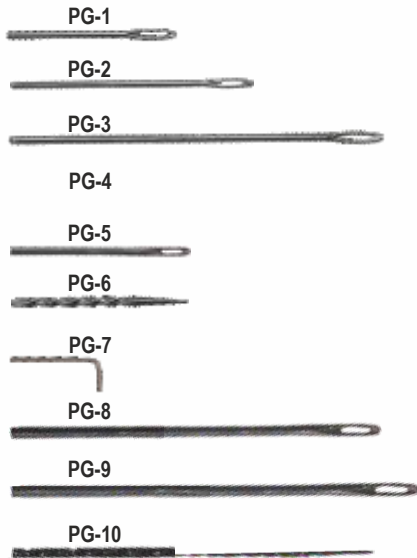

24 Needles



25 4400015



26 4400215



27 4400315



28 4400615



29 4400115



30 4400515

21 Chrome T- Handle Kit

Weight:
370gms

Code No.
4400010KIT

The Kit contains the following items:

Tool:	Size:	Qty:	Code No.
Chrome T-handle	-----	1 No.	4400010H
Spiral Probe	5"	1 No.	CT-1 CT-
Open Eye Needle	4"	1 No.	2 CT-3
Allen Key	-----	1 No.	

22 Pistol Grip Handle Kit

Weight:
125gms

Code No.
4400011KIT

The Kit contains the following items:

Tool:	Size:	Qty:	Code No.
Pistol Grip Handle	-----	1 No.	4400011H
Spiral Probe	5"	1 No.	CT-6 CT-
Open Eye Needle	4"	1 No.	1 CT-7
Allen Key	-----	1 No.	

23 Handle only for insertion with socket key and screw

Tool:	Weight:	Code No.
Chrome T- Handle	338gms	4400010H
Pistol Grip Handle	85gms	4400011H

24 Needles Only

Tool:	Size:	Weight:	Code No.
Open Eye Needle	4"	15gms	PG-1
Open Eye Needle	6"	15gms	PG-2
Open Eye Needle	8"	20gms	PG-3
Side Split Needle	8"	20gms	PG-4
Close Eye Needle	4"	10gms	PG-5
Spiral Probe	5"	20gms	PG-6
Allen Key	-----	5gms	PG-7
Close Eye Needle	8"	22gms	PG-8
Close Eye Needle	9"	25gms	PG-9
Truck Rasp Needle	8"	25gms	PG-10

25 Open Eye Needle in Plastic T-Handle

Colour:	Size:	Weight:	Code No.
Black	3"	60gms	4400015
Black	5"	70gms	4400415

26 Close Eye Needle in Plastic T-Handle

Colour:	Size:	Weight:	Code No.
Black	3"	65gms	4400215

27 Tyre Probe with Knurling in Plastic T-Handle

Colour:	Size:	Weight:	Code No.
Black	3"	60gms	4400315

28 Side Split Needle in Plastic T-Handle

Colour:	Size:	Weight:	Code No.
Black	3"	65gms	4400615

29 Spiral Probe Needle In Plastic T-Handle

Colour:	Size:	Weight:	Code No.
Black	4"	65gms	4400115

30 Rasp Passenger Car In Plastic T-Handle

Colour:	Size:	Weight:	Code No.
Black	4"	55gms	4400515



31 4400012



32 4400112



33 4400122



34 4400156



34 4400146



35 4400614



36 4400414



36 4400214



36 4400514



37 4400314

31 Rasp Passenger Car in Screw Driver PVC Handle

Colour:	Size:	Weight:	Code No.
Red	4"	45gms	4400012

32 Close Eye Passenger Car Needle in Screw Driver PVC Handle

Colour:	Size:	Weight:	Code No.
Red	4"	45gms	4400112

33 Side Split Needle in Screw Driver PVC Handle

Colour:	Size:	Weight:	Code No.
Red	4"	40gms	4400122

34 Side Split Needle With Knurling in Screw Driver PVC Handle

Colour:	Size:	Weight:	Code No.
Black	3"	35gms	4400156
Black	4"	45gms	4400146

35 Passenger Car Reamer in Screw Driver PVC Handle

Colour:	Size:	Weight:	Code No.
Black	3"	25gms	4400614

36 Truck Rasp in Screw Driver PVC Handle

Thickness:	Size:	Weight:	Code No.
6mm	6"	80gms	4400414
6mm	8"	100gms	4400214
8mm	8"	120gms	4400514

37 Truck Close Needle in Screw Driver Handle

Colour:	Size:	Weight:	Code No.
Black	8"	85gms	4400314

38 Side Split Needle Heavy Duty with Knurling in Screw Driver PVC Handle

Colour:	Size:	Weight:	Code No.
Red	8"	105gms	4400116

39 Side Split Needle with Knurling in Triangular Handle

Size:	Weight:	Code No.
4"	30gms	4400126



38 4400116



39 4400126

**40 Open Eye Needle in Pistol Grip Handle**

Colour:	Size:	Weight:	Code No.
Red	3"	80gms	4400118
Black	3"	80gms	4400118BK
Red	4"	82gms	4400818
Red	5"	85gms	4400218
Black	5"	85gms	4400218BK
Red	6"	90gms	4400718
Red	8"	100gms	4400518

41 Spiral Probe in Pistol Grip Handle

Colour:	Size:	Weight:	Code No.
Red	4"	85gms	4400018

42 Close Eye Needle in Pistol Grip Handle

Colour:	Size:	Weight:	Code No.
Red	4"	85gms	4400318
Red	8"	87gms	4401018

43 Passenger Car Rasp in Pistol Grip Handle

Colour:	Size:	Weight:	Code No.
Red	4"	90gms	4400114
Black	4"	90gms	4400114BK

44 Truck Rasp in Pistol Grip Handle

Colour:	Size:	Weight:	Code No.
Red	8"	100gms	4400014
Black	8"	100gms	4400014BK

45 Side Split Needle with Knurling in Pistol Grip Handle

Colour:	Size:	Weight:	Code No.
Red	4"	80gms	4400136

46 Side Split Needle Heavy Duty with Knurling in Pistol Grip Handle

Colour:	Size:	Weight:	Code No.
Red	8"	107gms	4400918

47 Side Split Needle in Pistol Grip Handle

Colour:	Size:	Weight:	Code No.
Black	3"	80gms	4400618

48 Side Split Needle in Pistol Grip Handle

Colour:	Size:	Weight:	Code No.
Black	6"	85gms	4400016
Red	8"	110gms	4400418





1 440037

1 Sarv Premium Kit (Tubeless Tyre Repair Kit in Plastic Box)

Weight: 1.600 kg
Code No. 440037

The Kit contains the following items:

Tool:	Size:	Qty:	Code No.
• Spiral Probe in Chrome T- Handle	4"	1 No.	44SP37
• Open Eye Needle in Chrome T-Handle	5"	1 No.	44OE37
• Allen Key	----	1 No.	CT-3
• Cutting Knife	----	1 No.	44SK47
• Paste	----	1 No.	44PA37
• Flap of 5 Repair Strings	4"	4 No.	44RS07

2 Sarv Super Seal Kit (Mushroom Type Tubeless Tyre Repair Kit)

Weight: 350gms
Code No. 440027

The Kit contains the following items:

Tool:	Size:	Qty:	Code No.
• Mushroom Patch	3mm	10 No.	440127
• Mushroom Patch	6mm	5 No.	440227
• Tube of Solution	20ml	5 No.	440827
• Angular Milling Cutter	6mm	1 No.	4401617
• Angular Milling Cutter	3mm	1 No.	4400317
• Spherical Rasp	38mm Ø	1 No.	440627
• Special Sticher for Mushroom Kit		1 No.	440727

Use : Rapid, reliable and permanent repair. Specially designed for puncture made by nails, scarves, bolts in tyres. Total compatibility with all makes of tyres.



3 Sarv Rad Seal Kit (Tubeless Tyre Repair Kit for Bicycles)

Weight: 65gms
Code No. 440047

The Kit contains the following items:

Tool:	Qty:	Code No.
• Reaming tool in Screw Driver type Handle	1 No.	44RT47
• Insertion tool in Screw Driver type Handle	1 No.	44IT47
• Small Cutting Knife	1 No.	44SK47
• Flap of 5 repair Strings 2" long, Dia. 4mm	2 No.	44RS06
• Instruction sheet	1 No.	



2 440027



3 440047



4 440007



5 440057



6 440067



7 44RS06



7 44RS07



7 44RS08

4 Saryv - Seal Kit (Tubeless Tyre Repair Kit)

Weight: 185gms
Code No. 440007

The Kit contains the following items:

Tool:	Size:	Qty:	Code No.
• Spiral Probe in PG Handle	4"	1 No.	44SP07
• Open Eye Needle in PG Handle	3"	1 No.	44OE07
• Cutting Knife	----	1 No.	44CK07
• Flap of 5 Repair Strings	4"	1 No.	44RS07
• Instruction Sheet		1 No.	

5 Saryv - Chrome Seal Kit (Tubeless Tyre Repair Kit)

Weight: 445gms
Code No. 440057

The Kit contains the following items:

Tool:	Size:	Qty:	Code No.
• Chrome T-Handle	----	1 No.	440010H
• Spiral Probe	4"	1 No.	44SP57
• Open Eye Needle	3"	1 No.	44OE57
• Allen Key	----	1 No.	CT-3
• Cutting Knife	----	1 No.	44CK07
• Flap of 5 Repair Strings	4"	1 No.	44RS07
• Instruction Sheet		1 No.	

6 Saryv - Blister Seal Kit (Tubeless Tyre Repair Kit)

Weight: 165gms
Code No. 440067

The Kit contains the following items:

Tool:	Size:	Qty:	Code No.
• Spiral Probe in PG Handle	4"	1 No.	44SP07
• Open Eye Needle in PG Handle	3"	1 No.	44OE07
• Small Cutting Knife	----	1 No.	44SK47
• Flap of 5 Repair Strings	4"	1 No.	44RS07

7 Repair Strings

Colour:	Size (Flap):	Weight:	Code No.
Brown	2" long	3gms	44RS06
Brown	4" long	15gms	44RS07
Black	4" long	15gms	44RS07BK
Brown	8" long	25gms	44RS08
Black	8" long	25gms	44RS08BK

Packaging: 1 flap consists of 5 repair Strings.



7 44RS07BK

